

产品概述
自动润滑器



simalube[®]
smart lubrication

司马泰克自动润滑器

使用司马泰克自动润滑器的好处	3
司马泰克自动润滑器- 润滑专家	4/5
司马泰克自动润滑器 15毫升	6
司马泰克多点润滑器	7
司马泰克加压润滑器	8/9
应用	10/11
标准自动润滑器	12
附件	13/14/15



司马泰克自动润滑器： 持续润滑确保低成本和高可靠性。

数以万计的司马泰克自动润滑器应用在全球每个工业领域。他们是最好最经济的持续润滑解决方案。无论油润滑还是脂润滑，时间可以长达一年。

司马泰克自动润滑器-适用于旋转机械和移动设备的每个角落。



Tom Maintain

因为我们的轴承值得拥有。

«一经安装，司马泰克自动润滑器将提供精准又可靠的润滑，这些都是手动润滑做不到的»

使用司马泰克自动润滑器的好处

司马泰克自动润滑器代替手动润滑，这不仅节约时间，还可以防止润滑不足和过量润滑。综合成本可以降低30%。

最优化的润滑量

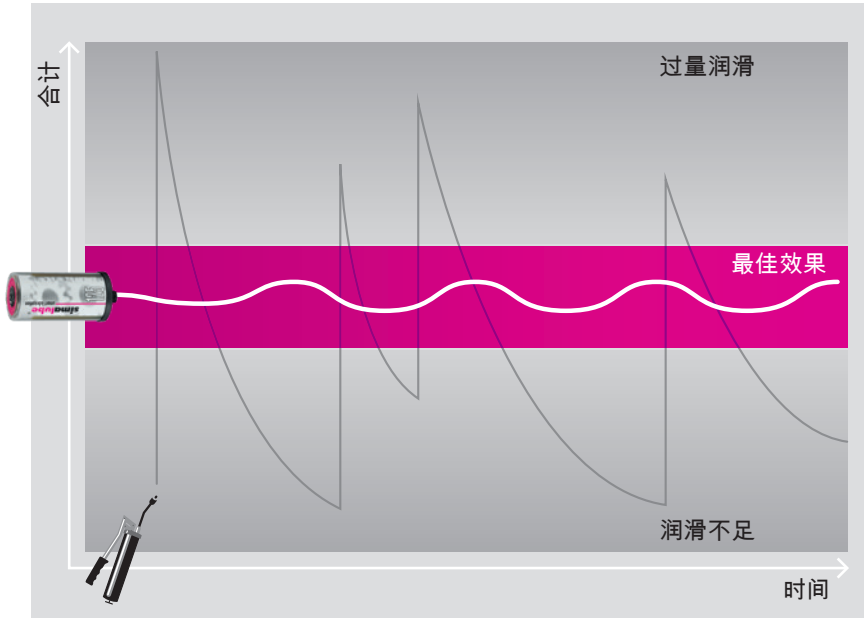

使用司马泰克自动润滑器确保持续润滑可以有效的避免手动润滑产生的过量润滑或者润滑不足。

司马泰克自动润滑器带来成本节约



可以降低高达30%的成本。

- 维护频率降低，节约时间同时增强工作安全性。
- 更长的机器服务寿命和更少的非计划停机时间。

使用司马泰克自动润滑器的益处



不需要更多的手动润滑。

- 节约时间
- 更好的工作安全性
- 持续润滑不易到达的润滑点
- 更低的润滑剂损耗



部件不会发生过量润滑或润滑不足

- 更低的磨损
- 更短的停机时间
- 增强机器性能

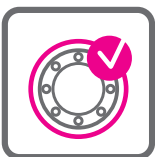

密封以及防尘防水

- 避免润滑剂混用现象
- 降低注油时被污染的风险
- 避免润滑点被污染



执行国际统一标准

- TUV和EX认证
- 工作场所安全
- 可循环处理材料，不会影响环境



司马泰克自动润滑器-润滑专家

司马泰克自动润滑器-单点式自动润滑器

5种标准型号，司马泰克自动润滑器为所有润滑点提供持续润滑，夜以继日，最长可达一年时间。

司马泰克自动润滑器的优势

可靠性

- 持续为润滑点提供润滑剂
- 避免遗漏润滑点
- 通过透明窗口可以随时监控润滑状态

可持续性

- 司马泰克自动润滑器可重复加油3次
- 用后易于处理
- 司马泰克自动润滑器不包含有毒物质

可选择性

- 司马泰克自动润滑器有5种标准型号：15，30，60，125 和250毫升
- 任意时间设置，从1-12个月
- 时间设置可随时更改
- 可提供空瓶或者预填充油脂的润滑器

无限的应用场合 (见10/11页)

- 不易到达
- 甚至水下
- 环境温度-20°C--+55°C
- 安装附件丰富，安装方式不限
- 市面常见型号的润滑剂均可用于自动润滑器 (详见12/13页)

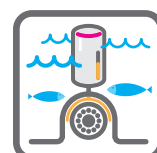
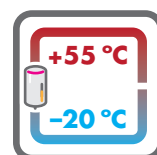
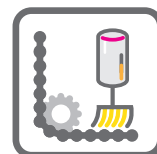

汤姆小
提示

更多的技术信息和使用手册可在www.simatec.com下载



组件

驱动器

压力腔

外壳

活塞

标签

润滑剂

接头



说明

产品	自动持续脂和油润滑器			
动力源	干电池电解产生氢气			
工作压力	最大5bar			
设置	1到12个月无级可调			
运行温度	环境温度-20°C到+55°C (润滑脂粘度随温度改变)			
存储温度	推荐温度在20°C ± 5			
润滑器容量	30 ml	60 ml	125 ml	250 ml
满重	~82 g	~115 g	~190 g	~335 g
空重	~55 g	~60 g	~75 g	~111 g
重复加油	15-250毫升都可以重复加油			



证书



simalube 250



simalube 125



simalube 60

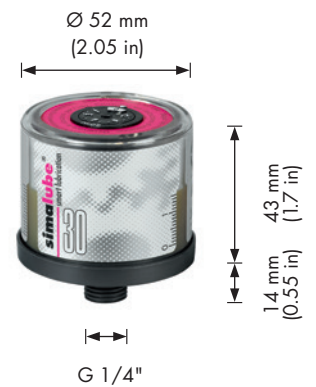

simalube 30



选型和时间设置, 请参考我们的网站www.simatec.com/en/calpro



司马泰克自动润滑器 15毫升



最小的自动润滑器

在狭窄空间，15毫升司马泰克自动润滑器提供最佳解决方案。得益于它的紧凑设计，使其成为全球唯一可用于狭窄空间的自动润滑器。它和其它尺寸自动润滑器具有一样的功能和优点。

小尺寸带来高性能

- 紧凑设计节省空间
- 结实耐用的铝制外壳
- 同样具备重复使用，易于安装和其它完整的功能
- 如果润滑点少于5个，可选多点式自动润滑器（参见7页）

外径

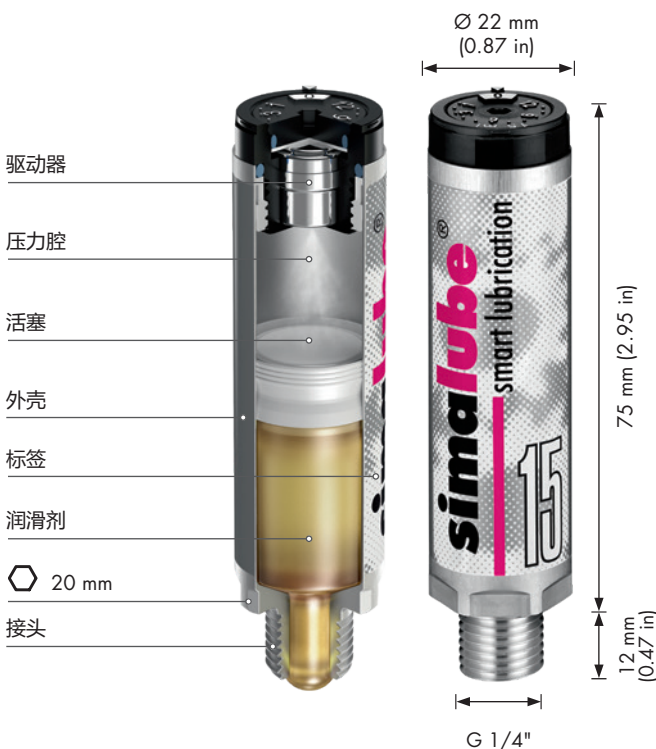

说明

产品	自动持续脂和油润滑器
动力源	干电池电解产生氢气
工作压力	最大5par
设置	1到12个月五级可调
运行温度度	环境温度-20°C到+50°C（润滑脂粘稠度随温度改变）
存储温度	推荐温度在20°C±5
润滑器容量	15 ml
重量 满/空	~36 g / ~22.5 g
证书	   

司马泰克多点润滑器



多点式自动润滑器

司马泰克多点式润滑器可以为5个润滑点提供持续润滑，像其它标准型号一样，最长可以使用一年时间。得益于快速卡扣设计，能够更快更方便的进行重复注油。

用于直线导轨的多功能润滑器

- 5X8毫升 润滑器容积
- 长时间低消耗的润滑应用
- 快速卡扣设计方便重复注油
- 快速接头设计方便安装软管
- 直线导轨的完美润滑方案

外径



说明

产品	自动，多点式持续脂和油润滑器
动力源	干电池电解产生氢气
工作压力	最大5bar
设置	1到12个月无级可调
运行温度改	环境温度 - 20到+55°C (油脂粘稠度随温度变)
存储温度	推荐温度: 20±5°C
润滑器容量	5×8 ml
重量 满/空	~147 g / ~120 g
证书	  

simalube IMPULSE connect



数字式增压器，最高可达 10 bar

simalube IMPULSE connect 是 Simalube 系列中最新一代的增压器产品。IMPULSE 久经验证的出色性能，如今有了可通过蓝牙 Bluetooth® 与智能手机连接的功能。连接到最新开发的“simatec world of maintenance”应用程序后，用户无需直接到场，便可从智能设备上对我们的设备产品进行配置。诸如整体状态、液位、润滑剂、尺寸规格、启动和更换日期等，均可在该应用程序中显示出来，供用户轻松查看。



技术数据

产品	simalube 润滑装置自动增压器
驱动系统	电动机械
供电方式	电池组* 6V 2.3Ah (碱性电池)
功能显示	LED 状态指示灯 - 绿色/红色/蓝色各 10 秒。通过 simatec world of maintenance 应用程序监控运行状态。
连接方式*	IMPULSE connect 支持蓝牙®低功耗 5.0 标准。在空旷无阻处连接范围可达 20m 米。
供送量	约 0.5ml 每行程 (Impulse)
工作压力	不超过 10 bar
工作温度	-10°C - +55°C (14°F - 131°F)
时间设置	1 - 12 个月 - 取决于在 simalube 的应用程序中设置了自动模式还是时间模式。
润滑速度	取决于 simalube 的尺寸和设置: 0.17 - 8.3ml/day
润滑装置容量	60 ml, 125 ml, 250 ml
润滑剂	润滑脂, 最高达 NLGI 2, 或润滑油
螺纹规格	G 1/4 " (内置单向阀)
保修期与使用寿命	自生产日期起 3 年, 或用尽 10 个 simalube 润滑器 (125ml) 后
防护能力	CE IP 68

- * 更换润滑器时, 必须同时更换电池组。
- * IMPULSE connect 增压器可离线使用



**TOM的
小建议**

更多的技术信息和视频资料请登录; www.simatec.com/en/impulse



READY TO LIFT OFF TO THE WORLD OF MAINTENANCE



Explore the next level
of automatic lubrication:
simalube IMPULSE connect



«simatec world of maintenance» 这款应用程序。

利用 simatec world of maintenance 应用程序，simatec AG 搭建了一个平台，可让润滑工作的管理更方便更高效。用户可利用该应用程序来记录润滑点，设置必要的润滑参数，控制和监控润滑相关的所有活动。simalube IMPULSE connect 配备有蓝牙®功能，可直接利用手机应用程序进行配置，可利用该应用程序，在最远不超过 20m 距离处查看当前运行状态。simatec world of maintenance 这款应用程序可从苹果应用商店或谷歌 Play 应用商店下载，安装到智能手机上。

数字化、紧凑且强大的产品

功能

- 可通过蓝牙®连接：连接距离可达 20m
- 可利用 Simatec world of maintenance 应用程序进行配置和监控
- 增压器增压可达 10 bar，线路长度可达 4m
- 模块化系统，适用于60、125和250ml规格的润滑器
- 持续时间设定范围为 1 到 12 个月
- 可用于润滑脂（最高 NLGI 等级 2）和润滑油
- 可对润滑剂实现轻柔输送，以较低压力从 simalube 润滑器输送至 IMPULSE
- 尺寸紧凑，可安装在任何位置

您的好处

- 可更快、更简单、更安全地完成检查，为您节约成本
- 监测更简单，当前状态显示十分清晰明了，信息丰富
- 对润滑表中的润滑点进行管理
- 通过该应用程序提供数字化支持：
 - 采用动画形式引导用户完成安装，提供使用说明
- 可利用时间模式或温度模式实现不间断润滑，减少了部件的磨损
- 不需因维护和监控目的而中断生产，从而提高生产系统的生产率



下载应用程序:





司马泰克自动润滑器应用

提升设备



铁路机车提升站的丝杠使用125ml润滑器

食品工业

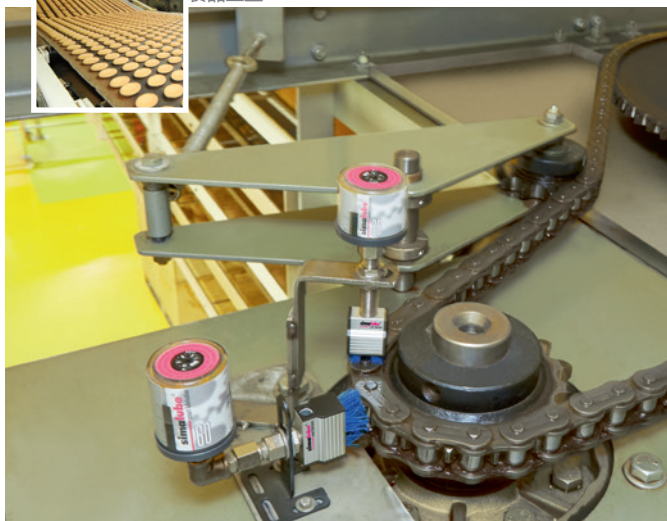

输送皮带的驱动链条使用30ml和60ml润滑器配合特制蓝色毛刷进行润滑

碎石机和混凝土机械



2个250ml司马泰克自动润滑器和毛刷用来清洁和润滑驱动链条

起重机



125ml司马泰克自动润滑器润滑起重机的旋转机械

碎石机和混凝土机械

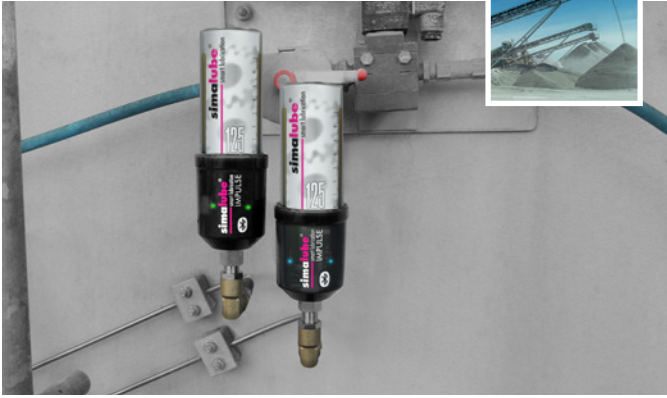

simalube IMPULSE connect 搭配 125 ml 润滑器用在土地环境中的设备上。这些设备均可以使用 simatec world of maintenance 应用程序来配置和监控。

电梯和自动扶梯



125ml自动润滑器保证电梯润滑和避免干摩，这个系统直接粘附在仓顶。

印刷机械



司马泰克多点润滑器可以润滑5个切纸机。

污水处理



60ml自动润滑器在一个电机上保证离心泵的持续润滑。

回收



125ml自动润滑器润滑传输带的带座轴承。

工程机械



15ml自动润滑器和毛刷为齿条进行油润滑，另外一个15ml润滑器为轴承进行脂润滑。



汤姆小提示

很多其他应用请参考; www.simatec.com/en/simalube-application.





标准润滑附件

润滑脂	NLGI	稠度	温度范围	粘度在40°C	应用						
					滚动轴承	滑动轴承	直线导轨	齿条, 齿轮	轴	密封	链条
SL01 防水, 长效油脂	2	锂-钙	-30到120°C	110	+	+	•	•	+	+	-
SL02 含MoS2高温润滑脂	2	锂	-25 °C to 130 °C	370	•	+	-	+	-	-	-
SL04 高温润滑脂 (EP)	2	无机增稠剂	-20 °C to 160 °C	540	+	•	-	•	•	-	-
SL06 防水, 液体油脂	0	锂	-30 °C to 100 °C	75	+	+	+	+	•	-	-
SL09 万能油脂 可分解	2	锂	-20 °C to 100 °C	100	+	+	•	•	-	-	-
SL10 食品级和生物工业特殊油脂	2	铝络合物	-40 °C to 130 °C	350	+	+	•	+	•	-	-
SL12 半流质食品工业油脂	0	铝络合物	-40 °C to 130 °C	350	+	+	+	+	•	-	-
SL24 润滑油脂 (EP)	2	锂合成	-30 °C to 140 °C	185	+	+	•	•	+	+	-
SL25 高温高分子油脂	2	高分子	-20 °C to 160 °C	110	+	•	-	•	•	-	-
SL26 钙硫合物油脂	1.5	钙混合物	-20 °C to 150 °C	460	+	+	-	•	•	-	-









+ 推荐 • 可能 - 不推荐



汤姆小提示

所有脂和油数据表可访问: www.simatec.com/en/lubricants.



润滑油	ISO-VG	基础油	温度范围	粘度在40度	应用						
					滚动轴承	滑动轴承	直线导轨	齿条, 齿轮	滚针	密封	链条
											
SL14 Chain oil (EP)	68	矿物油	-10 °C to 90 °C	68	-	•	•	-	-	-	+
SL15 高温链条油	-	合成油	-30 °C to 250 °C	250	-	•	•	-	-	-	+
SL16 石蜡油	68	矿物油	-20 °C to 100 °C	68	-	•	•	-	-	-	+
SL18 为食品, 生物制药的高性能润滑油。 	220	合成油	-15 °C to 150 °C	220	-	•	•	-	-	-	+
SL19 有机油	-	菜籽油	-15 °C to 100 °C	60	-	•	•	-	-	-	+

+ 推荐 • 可能 - 不推荐

应用案例

这些附件可以将司马泰克润滑器轻易地安装在任意位置

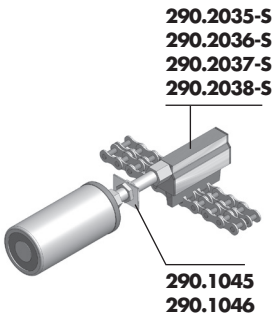
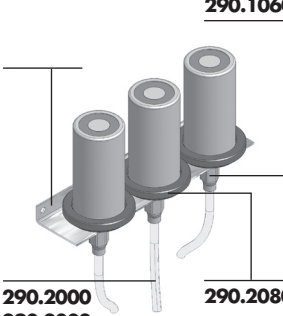
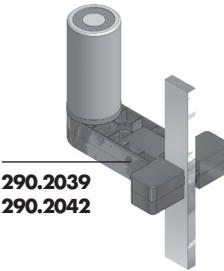
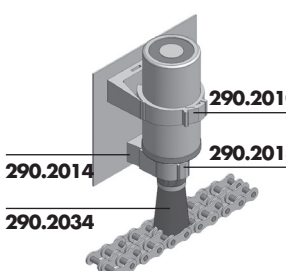
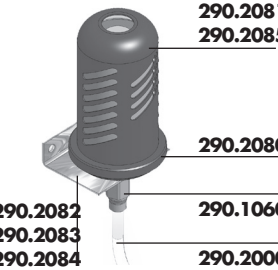
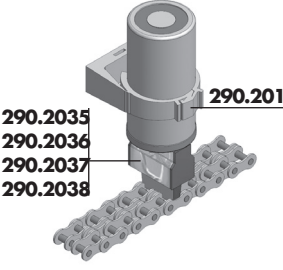
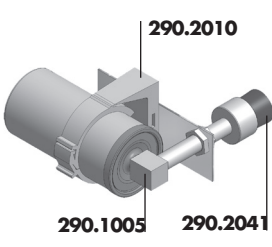
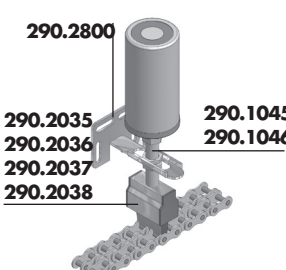
<p>侧面连接毛刷润滑链条</p>  <p>290.2035-S 290.2036-S 290.2037-S 290.2038-S</p> <p>290.1045 290.1046</p>	<p>安装支架</p>  <p>290.1060</p> <p>290.2000 290.2002 290.2004</p> <p>290.2080</p>	<p>电梯导轨或缆绳润滑</p>  <p>290.2039 290.2042</p>	<p>圆刷且通过双卡子固定润滑链条</p>  <p>290.2010 290.2013</p> <p>290.2014 290.2034</p>
<p>安装带保护罩润滑器</p>  <p>290.2081 290.2085</p> <p>290.2080</p> <p>290.2082 290.2083 290.2084</p> <p>290.1060</p> <p>290.2000 290.2002 290.2004</p>	<p>毛刷润滑链条</p>  <p>290.2010</p> <p>290.2035 290.2036 290.2037 290.2038</p>	<p>90度弯头连接圆刷</p>  <p>290.2010</p> <p>290.1005 290.2041</p>	<p>安装支架, 万向调节</p>  <p>290.2800</p> <p>290.2035 290.2036 290.2037 290.2038</p> <p>290.1045 290.1046</p>

接头

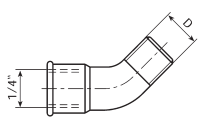
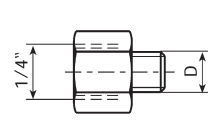
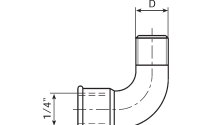
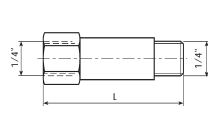
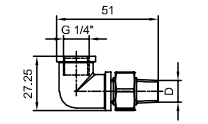
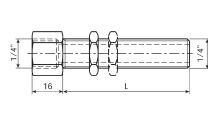
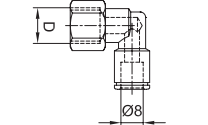
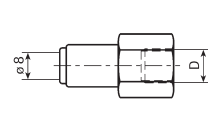
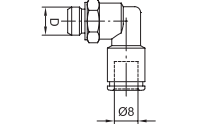
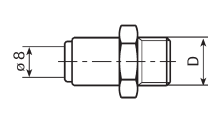
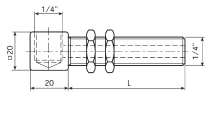
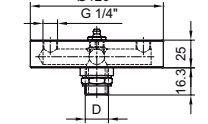
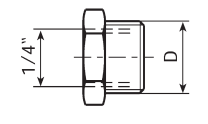
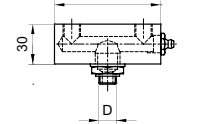
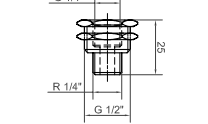
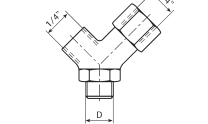
	<p>45°弯头</p> <p>D R 1/4 产品编码 290.1001</p>		<p>变径接头</p> <table border="1"> <tr> <td>D</td> <td>G 1/8</td> <td>G 1/4</td> <td>M 6</td> <td>M 8</td> <td>M 8×1</td> </tr> <tr> <td>产品编码</td> <td>290.1020</td> <td>290.1021</td> <td>290.1022</td> <td>290.1023</td> <td>290.1024</td> </tr> <tr> <td>D</td> <td>M 10</td> <td>M 10×1</td> <td>M 12</td> <td>M 12×1.5</td> <td>UNF 1/4</td> </tr> <tr> <td>产品编码</td> <td>290.1025</td> <td>290.1026</td> <td>290.1027</td> <td>290.1028</td> <td>290.1121</td> </tr> </table>	D	G 1/8	G 1/4	M 6	M 8	M 8×1	产品编码	290.1020	290.1021	290.1022	290.1023	290.1024	D	M 10	M 10×1	M 12	M 12×1.5	UNF 1/4	产品编码	290.1025	290.1026	290.1027	290.1028	290.1121
D	G 1/8	G 1/4	M 6	M 8	M 8×1																						
产品编码	290.1020	290.1021	290.1022	290.1023	290.1024																						
D	M 10	M 10×1	M 12	M 12×1.5	UNF 1/4																						
产品编码	290.1025	290.1026	290.1027	290.1028	290.1121																						
	<p>90°弯头</p> <p>D R 1/4 产品编码 290.1002</p>		<p>延伸接头</p> <table border="1"> <tr> <td>L</td> <td>10</td> <td>35</td> <td>50 [mm]</td> </tr> <tr> <td>产品编码</td> <td>290.1021</td> <td>290.1040</td> <td>290.1041</td> </tr> </table>	L	10	35	50 [mm]	产品编码	290.1021	290.1040	290.1041																
L	10	35	50 [mm]																								
产品编码	290.1021	290.1040	290.1041																								
	<p>万向90°弯头</p> <p>D R 1/4 产品编码 290.1004</p>		<p>1螺母固定加长接头</p> <table border="1"> <tr> <td>L</td> <td>25</td> <td>60 [mm]</td> </tr> <tr> <td>产品编码</td> <td>290.1045</td> <td>290.1046</td> </tr> </table>	L	25	60 [mm]	产品编码	290.1045	290.1046																		
L	25	60 [mm]																									
产品编码	290.1045	290.1046																									
	<p>内螺纹喉管弯头, 8mm</p> <p>D G 1/4 产品编码 290.1003</p>		<p>内螺纹快速接头, 8mm</p> <table border="1"> <tr> <td>D</td> <td>G 1/4</td> </tr> <tr> <td>产品编码</td> <td>290.1060</td> </tr> </table>	D	G 1/4	产品编码	290.1060																				
D	G 1/4																										
产品编码	290.1060																										
	<p>外螺纹喉管弯头, 8mm</p> <p>D G 1/8 G 1/4 产品编码 290.1007 290.1008</p>		<p>外螺纹快速接头, 8mm</p> <table border="1"> <tr> <td>D</td> <td>G 1/8</td> <td>G 1/4</td> <td>G 3/8</td> </tr> <tr> <td>产品编码</td> <td>290.1070</td> <td>290.1071</td> <td>290.1072</td> </tr> </table>	D	G 1/8	G 1/4	G 3/8	产品编码	290.1070	290.1071	290.1072																
D	G 1/8	G 1/4	G 3/8																								
产品编码	290.1070	290.1071	290.1072																								
	<p>90°双螺母调距固定接头</p> <p>L 70 [mm] 产品编码 290.1005</p>		<p>4倍适配器</p> <table border="1"> <tr> <td>D</td> <td>G 1/2</td> <td>G 1/4</td> </tr> <tr> <td>产品编码</td> <td>290.4100</td> <td>290.4101</td> </tr> </table>	D	G 1/2	G 1/4	产品编码	290.4100	290.4101																		
D	G 1/2	G 1/4																									
产品编码	290.4100	290.4101																									
	<p>转换接头</p> <p>D G 3/8 G 1/2 产品编码 290.1010 290.1011</p>		<p>2倍适配器</p> <table border="1"> <tr> <td>D</td> <td>G 1/2</td> <td>G 1/4</td> </tr> <tr> <td>产品编码</td> <td>290.4102</td> <td>290.4103</td> </tr> </table>	D	G 1/2	G 1/4	产品编码	290.4102	290.4103																		
D	G 1/2	G 1/4																									
产品编码	290.4102	290.4103																									
	<p>1螺母固定接头</p> <p>L 25 [mm] 产品编码 290.1015</p>		<p>Y型接头, 包括变径290.1021</p> <table border="1"> <tr> <td>D</td> <td>R 1/4</td> </tr> <tr> <td>产品编码</td> <td>290.1050</td> </tr> </table>	D	R 1/4	产品编码	290.1050																				
D	R 1/4																										
产品编码	290.1050																										

润滑器附件和组件

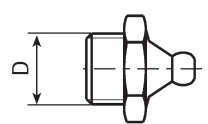
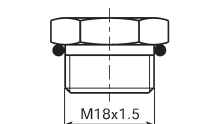
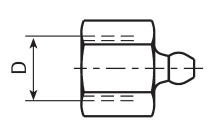
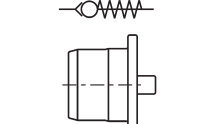
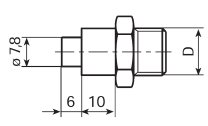
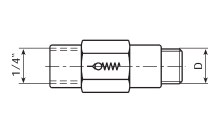
	<p>油孔油嘴</p> <p>D R 1/4 产品编码 290.3011</p>		<p>气体发生器</p> <table border="1"> <tr> <td></td> <td>15 ml</td> <td>30 ml</td> <td>60 ml</td> <td>125 ml</td> <td>250 ml</td> </tr> <tr> <td>产品编码</td> <td>220.5002</td> <td>220.5004</td> <td>220.5006</td> <td>220.5008</td> <td>220.5010</td> </tr> </table>		15 ml	30 ml	60 ml	125 ml	250 ml	产品编码	220.5002	220.5004	220.5006	220.5008	220.5010
	15 ml	30 ml	60 ml	125 ml	250 ml										
产品编码	220.5002	220.5004	220.5006	220.5008	220.5010										
	<p>润滑器油嘴</p> <p>D G 1/4 产品编码 290.3012</p>		<p>单向阀塞</p> <table border="1"> <tr> <td>产品编码</td> <td>290.5060</td> </tr> </table>	产品编码	290.5060										
产品编码	290.5060														
	<p>灌装接头</p> <p>D R 1/4 R 3/8 产品编码 290.3013 290.3014</p>		<p>单向阀</p> <table border="1"> <tr> <td>D</td> <td>G 1/8</td> <td>G 1/4</td> </tr> <tr> <td>产品编码</td> <td>290.2020</td> <td>290.2021</td> </tr> </table>	D	G 1/8	G 1/4	产品编码	290.2020	290.2021						
D	G 1/8	G 1/4													
产品编码	290.2020	290.2021													

安全附件

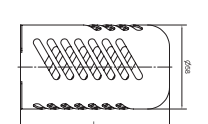
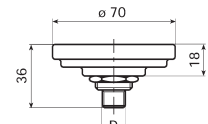
	<p>保护罩</p> <table border="1"> <tr> <td></td> <td>≤125 ml</td> <td>250 ml</td> </tr> <tr> <td>L</td> <td>105</td> <td>195 [mm]</td> </tr> <tr> <td>产品编码</td> <td>290.2081</td> <td>290.2085</td> </tr> </table>		≤125 ml	250 ml	L	105	195 [mm]	产品编码	290.2081	290.2085		<p>安装支架</p> <table border="1"> <tr> <td>D</td> <td>R 1/4</td> </tr> <tr> <td>产品编码</td> <td>290.2080</td> </tr> </table>	D	R 1/4	产品编码	290.2080
	≤125 ml	250 ml														
L	105	195 [mm]														
产品编码	290.2081	290.2085														
D	R 1/4															
产品编码	290.2080															

毛刷

	<p>圆刷</p> <p>D x L $\varnothing 25 \times 45$ [mm] 产品编码 290.2034</p>		<p>侧面连接毛刷, 食品级</p> <table border="1"> <tr> <td>L</td> <td>25</td> <td>40</td> <td>70</td> <td>100 [mm]</td> </tr> <tr> <td>产品编码</td> <td>290.2038-S</td> <td>290.2035-S</td> <td>290.2036-S</td> <td>290.2037-S</td> </tr> <tr> <td>产品编码</td> <td>290.2038-SFN</td> <td>290.2035-SFN</td> <td>290.2036-SFN</td> <td>290.2037-SFN</td> </tr> </table>	L	25	40	70	100 [mm]	产品编码	290.2038-S	290.2035-S	290.2036-S	290.2037-S	产品编码	290.2038-SFN	290.2035-SFN	290.2036-SFN	290.2037-SFN		
L	25	40	70	100 [mm]																
产品编码	290.2038-S	290.2035-S	290.2036-S	290.2037-S																
产品编码	290.2038-SFN	290.2035-SFN	290.2036-SFN	290.2037-SFN																
	<p>短圆刷</p> <p>D x L $\varnothing 25 \times 15$ [mm] 产品编码 290.2041</p>		<p>电梯刷, 5-16mm, 高32mm 电梯刷, 16-32mm, 高32mm</p> <table border="1"> <tr> <td>产品编码</td> <td>290.2039</td> <td>镍</td> <td>290.2044</td> </tr> </table>	产品编码	290.2039	镍	290.2044													
产品编码	290.2039	镍	290.2044																	
	<p>毛刷, 食品级</p> <table border="1"> <tr> <td>L</td> <td>25</td> <td>40</td> <td>70</td> <td>100 [mm]</td> </tr> <tr> <td>产品编码</td> <td>290.2038</td> <td>290.2035</td> <td>290.2036</td> <td>290.2037</td> </tr> <tr> <td>产品编码</td> <td>290.2038-FN</td> <td>290.2035-FN</td> <td>290.2036-FN</td> <td>290.2037-FN</td> </tr> </table>	L	25	40	70	100 [mm]	产品编码	290.2038	290.2035	290.2036	290.2037	产品编码	290.2038-FN	290.2035-FN	290.2036-FN	290.2037-FN		<p>小电梯刷, 5-16mm, 高32mm</p> <table border="1"> <tr> <td>产品编码</td> <td>290.2042</td> </tr> </table>	产品编码	290.2042
L	25	40	70	100 [mm]																
产品编码	290.2038	290.2035	290.2036	290.2037																
产品编码	290.2038-FN	290.2035-FN	290.2036-FN	290.2037-FN																
产品编码	290.2042																			
			<p>导轨刷, 40-50mm, 高度 32mm</p> <table border="1"> <tr> <td>产品编码</td> <td>290.2046</td> </tr> </table>	产品编码	290.2046															
产品编码	290.2046																			

安装附件

	<p>a) 软管 b) 软管可用于温度达到260°C c) 小弯曲半径软管</p> <table border="1"> <tr> <td>L</td> <td>每米, $\varnothing 8/6$ mm</td> <td></td> <td></td> </tr> <tr> <td>产品编码</td> <td>290.2000/...m</td> <td>290.2002/...m</td> <td>290.2004/...m</td> </tr> </table>	L	每米, $\varnothing 8/6$ mm			产品编码	290.2000/...m	290.2002/...m	290.2004/...m		<p>圆刷固定间隔</p> <table border="1"> <tr> <td>H</td> <td>15 [mm]</td> </tr> <tr> <td>产品编码</td> <td>290.2014</td> </tr> </table>	H	15 [mm]	产品编码	290.2014												
L	每米, $\varnothing 8/6$ mm																										
产品编码	290.2000/...m	290.2002/...m	290.2004/...m																								
H	15 [mm]																										
产品编码	290.2014																										
	<p>圆刷/润滑器用塑料固定卡子</p> <table border="1"> <tr> <td>D</td> <td>22</td> <td>28</td> <td>50 [mm]</td> </tr> <tr> <td></td> <td>(SL 15 ml)</td> <td>(round brush)</td> <td>(SL 30-250 ml)</td> </tr> <tr> <td>产品编码</td> <td>290.2015</td> <td>290.2013</td> <td>290.2010</td> </tr> </table>	D	22	28	50 [mm]		(SL 15 ml)	(round brush)	(SL 30-250 ml)	产品编码	290.2015	290.2013	290.2010		<p>固定支架</p> <table border="1"> <tr> <td></td> <td>1x</td> <td>3x</td> <td>5x</td> </tr> <tr> <td>L</td> <td>75</td> <td>240</td> <td>390 [mm]</td> </tr> <tr> <td>产品编码</td> <td>290.2082</td> <td>290.2083</td> <td>290.2084</td> </tr> </table>		1x	3x	5x	L	75	240	390 [mm]	产品编码	290.2082	290.2083	290.2084
D	22	28	50 [mm]																								
	(SL 15 ml)	(round brush)	(SL 30-250 ml)																								
产品编码	290.2015	290.2013	290.2010																								
	1x	3x	5x																								
L	75	240	390 [mm]																								
产品编码	290.2082	290.2083	290.2084																								
	<p>磁铁固定器</p> <table border="1"> <tr> <td>产品编码</td> <td>290.2019</td> </tr> </table>	产品编码	290.2019		<p>安装支架 用于 15-60 ml</p> <table border="1"> <tr> <td>产品编码</td> <td>290.2087</td> </tr> </table>	产品编码	290.2087																				
产品编码	290.2019																										
产品编码	290.2087																										
	<p>空间补偿环</p> <table border="1"> <tr> <td>D</td> <td>50 [mm]</td> </tr> <tr> <td>产品编码</td> <td>290.2012</td> </tr> </table>	D	50 [mm]	产品编码	290.2012		<p>万向调节固定支架</p> <table border="1"> <tr> <td>产品编码</td> <td>290.2800</td> </tr> </table>	产品编码	290.2800																		
D	50 [mm]																										
产品编码	290.2012																										
产品编码	290.2800																										

司马泰克多点润滑安装组件

	<p>快插接头</p> <table border="1"> <tr> <td>D</td> <td>G 1/8</td> <td>G 1/4</td> <td>M 5</td> <td>M 6</td> </tr> <tr> <td>产品编码</td> <td>290.1170</td> <td>290.1171</td> <td>290.1172</td> <td>290.1173</td> </tr> </table>	D	G 1/8	G 1/4	M 5	M 6	产品编码	290.1170	290.1171	290.1172	290.1173		<p>软管, 按米计</p> <table border="1"> <tr> <td>L</td> <td>每米</td> <td>$\varnothing 4/2.7$ mm</td> </tr> <tr> <td>产品编码</td> <td>290.2100/...m</td> <td></td> </tr> </table>	L	每米	$\varnothing 4/2.7$ mm	产品编码	290.2100/...m	
D	G 1/8	G 1/4	M 5	M 6															
产品编码	290.1170	290.1171	290.1172	290.1173															
L	每米	$\varnothing 4/2.7$ mm																	
产品编码	290.2100/...m																		
	<p>SLM接头</p> <table border="1"> <tr> <td>D</td> <td>5 x $\varnothing 4$ mm</td> </tr> <tr> <td>产品编码</td> <td>290.2900</td> </tr> </table>	D	5 x $\varnothing 4$ mm	产品编码	290.2900														
D	5 x $\varnothing 4$ mm																		
产品编码	290.2900																		

预润滑润滑脂或油容器

	<p>润滑桶400ml</p> <table border="1"> <tr> <td></td> <td>SL01</td> <td>SL02</td> <td>SL04</td> <td>SL06</td> <td>SL09</td> </tr> <tr> <td>产品编码</td> <td>290.7001</td> <td>290.7002</td> <td>290.7004</td> <td>290.7006</td> <td>290.7009</td> </tr> <tr> <td></td> <td>SL10</td> <td>SL12</td> <td>SL24</td> <td>SL25</td> <td>SL26</td> </tr> <tr> <td>产品编码</td> <td>290.7010</td> <td>290.7012</td> <td>290.7024</td> <td>290.7025</td> <td>290.7026</td> </tr> </table>		SL01	SL02	SL04	SL06	SL09	产品编码	290.7001	290.7002	290.7004	290.7006	290.7009		SL10	SL12	SL24	SL25	SL26	产品编码	290.7010	290.7012	290.7024	290.7025	290.7026		<p>油杯0.5l</p> <table border="1"> <tr> <td></td> <td>SL14</td> <td>SL15</td> <td>SL16</td> <td>SL18</td> <td>SL19</td> </tr> <tr> <td>产品编码</td> <td>290.7114</td> <td>290.7115</td> <td>290.7116</td> <td>290.7118</td> <td>290.7119</td> </tr> </table>		SL14	SL15	SL16	SL18	SL19	产品编码	290.7114	290.7115	290.7116	290.7118	290.7119
	SL01	SL02	SL04	SL06	SL09																																		
产品编码	290.7001	290.7002	290.7004	290.7006	290.7009																																		
	SL10	SL12	SL24	SL25	SL26																																		
产品编码	290.7010	290.7012	290.7024	290.7025	290.7026																																		
	SL14	SL15	SL16	SL18	SL19																																		
产品编码	290.7114	290.7115	290.7116	290.7118	290.7119																																		

司马泰克自动润滑器增压器附件

	<p>simalube IMPULSE connect, 增压器</p> <table border="1"> <tr> <td>产品编码</td> <td>230.1010</td> </tr> </table>	产品编码	230.1010		<p>电池组</p> <table border="1"> <tr> <td>动力</td> <td>6 V 2.3 Ah</td> </tr> <tr> <td>产品编码</td> <td>230.5000</td> </tr> </table>	动力	6 V 2.3 Ah	产品编码	230.5000
产品编码	230.1010								
动力	6 V 2.3 Ah								
产品编码	230.5000								

simatec ag

Stadthof 2, CH-3380 Wangen a. Aare

Tel.: +41 (0)32 636 50 00

Fax: +41 (0)32 636 50 19

welcome@simatec.com

www.simatec.com



录像

司马泰克-创新的方法带来客户价值

司马泰克是一个国际性公司，1983年成立于瑞士，通过创新和发展，创立了simalube、simatherm和simatool的产品品牌，广泛应用于全球圆柱滚子轴承行业的维护。

致力于为客户带来切实利益，通过最新的技术，司马泰克简化了复杂的维护流程，为全球数以万计的设备降低了维护成本。

优选合适的伙伴销售司马泰克产品，为用户带来专业可靠的指导和建议。

司马泰克维护产品-工业技术



自动润滑器

司马泰克自动润滑器可以提供1个月到1年时间的持续润滑。它可以为每个润滑点提供理想剂量的润滑剂，无论是油润滑还是脂润滑。因此，不再需要手动润滑，并从长远角度降低维护成本。



感应加热器

司马泰克感应加热器可以在短时间内加热圆形金属部件，比如滚子轴承，使其能够更快更有效率的安装。无论从经济角度还是生态角度，感应加热都是更有效的加热方式。在这个领域，司马泰克是全球领先的设备制造商。



拆装工具

拆装工具箱能够快速安装或者拆除圆柱滚子轴承和密封圈，现已应用于全球各个行业的生产和维护车间。