

**Anwenderhinweise  
Technische Information**

Vor Gebrauch lesen

**DE**

**User Manual  
Technical Information**

Read before use

**EN**

**Mode d'emploi  
Informations techniques**

A lire avant utilisation

**FR**

**Manual del usuario  
Información técnica**

Leer antes de usar

**ES**

**Istruzioni per l'uso  
Informazioni tecniche**

Leggere le istruzioni prima dell'uso

**IT**

Zubehör / Accessories  
Accessoires / Accesorios / Accessori



Get the simatec app «world of maintenance»



Download on the  
App Store



GET IT ON  
Google Play



**DE** **Deutsch** Original 3–8**EN** **English** Translation 9–14**FR** **Français** Traduction 15–20**ES** **Espanñl** Traducción 21–26**IT** **Italiano** Traduzione 27–32Zubehör / Accessories / Accessoires 33–38  
/ Accesorios / Accessori**Get the simatec app «world of maintenance»**

With the «simatec world of maintenance» app, simatec ag has created a platform for easier and more efficient management of lubrication work. The app offers the user the possibility to record lubrication points, to set the necessary parameters for the lubrication and to control or monitor all activities around the lubrication. The simalube IMPULSE connect, equipped with Bluetooth<sup>®</sup>, can be configured directly via the app. The current operating status can be viewed from a distance of up to 20m via the app. The «simatec world of maintenance» app can be downloaded from the Apple Store and the Google Play Store and installed on the smartphone.



# Produktspezifikation

Produkt	Automatischer Einzelpunkt-Langzeitspender für Fette und Öle.			
Bestimmungsgemäße Verwendung	Die automatischen Schmierstoffspender simalube werden an Maschinen und Anlagen zur Schmierung von Bauteilen jeglicher Art verwendet. Der Anbau erfolgt direkt oder über speziell dazu ausgelegte Zubehörteile.			
Antriebssystem	Wasserstoff-Gasentwicklungszelle (Trockenelement)			
Betriebsdruck	max. 5 bar			
Einstellung	stufenlos 1–12 Monate (für Standardbedingungen)			
Spendemenge	siehe Tabellen auf Seite 5			
Einsatztemperatur	–20 °C bis +55 °C Umgebungstemperatur (Hinweis: Fettkonsistenz ändert sich mit der Temperatur)			
Einsatz	Die Spender können in allen Positionen montiert werden, sogar unter Wasser. Achtung: nicht direkter Hitze aussetzen.			
Risiken/Gefahren	Trotz sorgfältigster Konstruktion kann es zu Hautkontakt mit Schmierstoff kommen. Dieser ist sofort mittels Wasser/Reinigungsmittel zu entfernen.			
Schutzart	IP68 (staub- und wasserdicht)			
Verwendungszeit	Innerhalb von 2 Jahren nach Produktionsdatum aktivieren			
Lagerungstemperatur	empfohlen bei 20 °C ±5 °C			
	<b>30 ml</b>	<b>60 ml</b>	<b>125 ml</b>	<b>250 ml</b>
Gewicht voll	~82 g	~115 g	~190 g	~335 g
Gewicht leer	~55 g	~60 g	~75 g	~111 g

simalube wurde von folgenden Institutionen auf Sicherheit geprüft und zugelassen:

- TÜV SÜD Product Service GmbH, Germany, Nr. Z1 16 12 29499 023
- TÜV SÜD Product Service GmbH, Germany, Nr. EX2A 029499 0024
- TÜV SÜD Product Service GmbH, Germany, DE/TPS/QAR20.0016/00
- DEKRA Certification B.V., Netherlands, Nr. KEMA 09ATEX0098X
- DEKRA Certification B.V., Netherlands, Nr. IECEx DEK 20.0032X

## Kennzeichnung Typ 30, 60, 125 ml:

II 1 G Ex ia IIC T6 Ga  
 II 1 D Ex ia IIIC T<sub>200</sub> 80 °C Da  
 I M1 Ex ia I Ma

## Kennzeichnung Typ 250 ml:

II 1 G Ex ia IIC T4 Ga  
 II 1 D Ex ia IIIC T<sub>200</sub> 135 °C Da  
 I M1 Ex ia I Ma



**simalube 30**



**simalube 60**



**simalube 125**



**simalube 250**

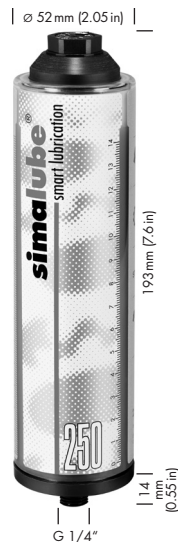

## Einbau und Inbetriebnahme



- 1) Schmierstoffauslass öffnen indem der Verschlussstopfen entfernt wird.

### Bei ölbefüllten Spendern Stopfen nicht entfernen!

Vorstehenden Nippel mit Messer abschneiden, bis ein kleiner schwarzer Punkt sichtbar wird (Öffnung ist nun gewährleistet).



- 2) Um den simalube Schmierstoffspender zu starten, wird die Spendezeit (in Monaten stufenlos wählbar zwischen 1–12) am Antriebskopf mittels Innensechskantschlüssel (SW3) eingestellt. Ist die Spendezeit eingestellt, ist der Spender aktiviert. Gewünschte Spendemenge aus den Tabellen (S. 5) ableiten.

- 3) Startdatum mit wasserfestem Filzstift auf Etikette eintragen.



- 4) Fettkanäle mittels Fettpresse durchschmieren. simalube an Schmierstelle einschrauben. Wenn erforderlich Zubehörteile S. 33–39 verwenden. Sicherheitshinweis beachten.
- 5) Nach Ablauf der vorgewählten Laufzeit den leeren Schmierstoffspender durch gleichen Typ ersetzen oder nachfüllen. Vor erneuter Inbetriebnahme Fettkanäle mittels Fettpresse durchschmieren.

- 6) Der Antriebskopf reicht für **eine** Entleerung, **unabhängig von der eingestellten Laufzeit.**

**Sicherheitshinweis:** Wird der Spender ohne zu öffnen in Betrieb genommen, oder sind die Fettkanäle verstopft, kann sich der Druck im Spender bis zu ca. 5 bar aufbauen. Bei einem Überdruck von ca. 6 bar platzt der Spender an der Sollbruchstelle zwischen Gehäuse und Trichter. Der Druck hinter dem Kolben entspannt sich, aus der Sollbruchstelle kann Fett oder Öl austreten.



**Warnung:** Bei Anwendungen in explosionsgefährdeten Gas- oder Staubatmosphären müssen Sicherheitsvorkehrungen getroffen werden, um das Risiko einer elektrostatischen Entladung oder von Bürstenentladungen an der Produktoberfläche zu minimieren. Die Reinigung der Oberfläche muss mit einem feuchten Tuch erfolgen.

Die einwandfreie Funktion des Schmierstoffspendensystems wird nur durch Verwendung der empfohlenen Schmierstoffe (Übersicht S. 8) des original simalube Zubehörprogramms und bei Beachtung der Montage-, Betriebs- und Wartungsvorschriften erreicht. Bei Nichtbeachtung dieser Vorschriften schliesst der Hersteller jegliche Haftung für Folgeschäden aus. **Wichtig:** Vor Inbetriebnahme des simalube, Verlängerungen und Fettleitungen mit entsprechendem simalube Fett (Kartuschen SL01...SL26) mittels Fettpresse durchschmieren und Fettkanäle füllen. Nur Originalzubehör verwenden.

## Temperatur/Spendemengen

Die Spendemenge kann bei Bedarf in Abhängigkeit von der Umgebungstemperatur stufenlos angepasst werden (vgl. Tabelle).

**Beispiel:** Die gewünschte Laufzeit für einen simalube 125 ml beträgt 180 Tage.  
Umgebungstemperatur: 20 °C Einstellung: 6  
Umgebungstemperatur: 55 °C Einstellung: 7



### simalube 30

Laufzeit (Tage)	30	90	180	270	360
ml/Tag	1,00	0,33	0,17	0,11	0,08
Temperatur	Einstellung	Einstellung	Einstellung	Einstellung	Einstellung
-20 °C	+	2	3.5	5.5	7.5
4 °C	+	2.5	5	7.5	10.5
<b>20 °C</b>	<b>1</b>	<b>3</b>	<b>6</b>	<b>9</b>	<b>12</b>
40 °C	1	3	6.5	9.5	-
55 °C	1	3.5	7	10.5	-

- + Größeren Spender mit höherer Laufzeit verwenden
- Kleinstmögliche Spendemenge erreicht

### simalube 60

Laufzeit (Tage)	30	90	180	270	360
ml/Tag	2,00	0,67	0,33	0,22	0,17
Temperatur	Einstellung	Einstellung	Einstellung	Einstellung	Einstellung
-20 °C	+	2	4	6.5	8
4 °C	+	2.5	5.5	9	10.5
<b>20 °C</b>	<b>1</b>	<b>3</b>	<b>6</b>	<b>9</b>	<b>12</b>
40 °C	1	3	6.5	9.5	-
55 °C	1	3.5	7	10.5	-

- + Größeren Spender mit höherer Laufzeit verwenden
- Kleineren Spender mit niedrigerer Laufzeit verwenden

### simalube 125

Laufzeit (Tage)	30	90	180	270	360
ml/Tag	4,17	1,39	0,69	0,46	0,35
Temperatur	Einstellung	Einstellung	Einstellung	Einstellung	Einstellung
-20 °C	+	2	4	6.5	8.5
4 °C	+	2.5	5.5	8	10.5
<b>20 °C</b>	<b>1</b>	<b>3</b>	<b>6</b>	<b>9</b>	<b>12</b>
40 °C	1	3	6.5	9.5	-
55 °C	1	3.5	7	10	-

- + Größeren Spender mit höherer Laufzeit verwenden
- Kleineren Spender mit niedrigerer Laufzeit verwenden

### simalube 250

Laufzeit (Tage)	30	90	180	270	360
ml/Tag	8,33	2,78	1,39	0,93	0,69
Temperatur	Einstellung	Einstellung	Einstellung	Einstellung	Einstellung
-20 °C	++	2	4.5	7.5	9.5
4 °C	++	2.5	5.5	8	10.5
<b>20 °C</b>	<b>1</b>	<b>3</b>	<b>6</b>	<b>9</b>	<b>12</b>
40 °C	1	3	6	9	-
55 °C	1	3.5	6.5	9.5	-

- ++ 2-fach-Adapter verwenden
- Kleineren Spender mit niedrigerer Laufzeit verwenden

Die Werte beziehen sich auf Laborbedingungen, SLO1 bei freiem Auslauf. Vor allem bei tiefen Temperaturen können die Werte zwischen den verschiedenen Fetten abweichen. Die Spender müssen nach Ablauf der eingestellten Laufzeit ersetzt werden, auch wenn sie nicht vollständig entleert sind.

Die gespendete Fettmenge/Tag wird beeinflusst durch:

- den Widerstand/Gegendruck im Leitungssystem
- die Umgebungstemperatur
- die Viskosität des Schmierstoffes

### Anlaufzeit:

Der Schmierstoffspender benötigt eine Anlaufzeit bis zum ersten Schmierstoffaustritt. Die Anlaufzeit variiert entsprechend der gewählten Spendemenge, Spendergröße und Betriebstemperatur. Beispielsweise bei 20 °C Umgebungstemperatur und einer Spendedauer-einstellung von 12 Monaten fördert der Spender innerhalb einer Woche Schmierstoff. Bei tiefen Temperaturen (-20 °C) oder kleinen Spendern (30 ml) verdoppelt sich die Anlaufzeit.

Die Anlaufzeit kann reduziert werden, indem man den Schmierstoffspender für ein bis zwei Tage mit einer Spendedauer von einem Monat und danach auf die gewünschte Spendedauer einstellt.

### Kostenlose Online-Programme:

### simatec App «world of maintenance»:



Calculation Pro



Lubechart



### Hinweise:

Wichtig für das zuverlässige Funktionieren sind durchgängig gefüllte Fettkanäle. Es muss sichergestellt werden, dass die Fettkanäle nicht verstopft sind. Deshalb müssen diese vor jeder Inbetriebnahme der Spender mittels Fettpresse durchgeschmiert werden.

Der simalube kann während der Spendezeit verstellt oder abgeschaltet werden. Die Werte auf der Einstellscheibe beziehen sich auf die Laborbedingungen (siehe Seite 4). Abhängig von Einstellung und Temperatur kann es nach dem Starten einige Stunden, bei Langzeiteinstellungen einige Tage bis zum ersten Schmierstoffaustritt dauern. Der Anwender muss die Funktion des simalubes regelmässig kontrollieren.

Anschlussleitungen dürfen nicht länger als 0,5 m sein. Empfohlener Bohrungsdurchmesser: 6–8 mm. Leitungswiderstände sind zu minimieren, Verengungen und eckige Winkel sind nicht zulässig. Bei starken Vibrationen oder hohen Beschleunigungen Montagesupport (Zubehör S. 33–39) verwenden. Bei längeren Schmierleitungen oder hohem Gegendruck den Druckverstärker simalube IMPULSE connect (Art. 230.1010) verwenden.

Der simalube darf nur für die Versorgung von **einer** Schmierstelle verwendet werden. Es dürfen keine Verzweigungen gemacht werden. Ist der Spender installiert und aktiviert, darf er nicht abgeschraubt und auf eine andere Schmierstelle montiert werden.

## Recycling-Hinweis



- 1) Antriebskopf herausschrauben (SW21) und zerlegt ins Batterie-Recycling geben.  
**Hinweis:** Nie in der Nähe von offenem Feuer herausschrauben.
- 2) Leeres Gehäuse ins Kunststoff-Recycling geben. Noch vorhandene Fettreste sind separat zu entsorgen. Lokale Vorschriften beachten.

## Erst- und Wiederbefüllung (bei kleinen Stückzahlen)

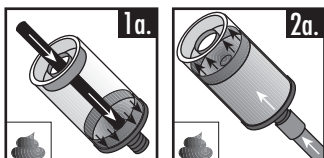

### Erstbefüllung mit Fett

1a. Kolben durch leichtes Anblasen mit Druckluft oder mit Hilfe eines Plastikstabes (Durchmesser 7 mm) ganz nach vorne, Richtung Trichter bzw. Auslassöffnung schieben.



2a. Nachfüllnippel Art. 290.3012 aufschrauben und Fettpresse anschliessen, oder Anschlussnippel Art. 290.3013 bzw. 290.3014 auf Fettpresse aufschrauben. Der Spender wird dabei während dem Füllvorgang gegen den Adapter gedrückt gehalten. Dadurch entfällt das wiederholte Aufschrauben des Nachfüllnippels. Fett in den Spender pressen.

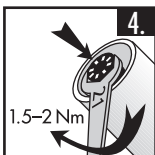
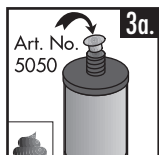

Auf blasenfreie Füllung achten. Füllvorgang so lange fortsetzen, bis der Kolben ganz zurückgeschoben ist. Nicht überfüllen!

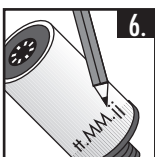
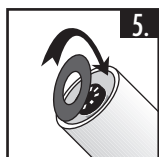

**Vorsicht: Handhebelpressen können bis zu 80 bar Druck aufbauen. Dies kann ausreichen, um den Spender zu zerstören!**

3a. Wenn der Spender zwischengelagert werden soll, Verschlussstopfen einsetzen.

4. Antriebskopf einsetzen (auf korrekten Sitz des O-Ringes achten) und mit Drehmomentschlüssel 1,5–2,0 Nm festziehen.

**Immer Original simalube Antriebsköpfe verwenden.**

5. Rondelle einschnappen.

6. Fettbezeichnung und Fülldatum auf der Etiketle notieren.

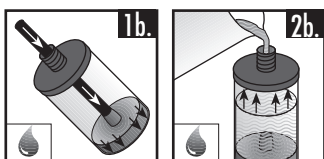

### Erstbefüllung mit Öl

1b. Kolben ganz nach hinten schieben (Richtung Antriebskopf).

2b. Öl über Trichteröffnung einfüllen.

3b. Rückschlagventilstopfen (gelb, Art. 290.5060) einsetzen.

4.–6. Wie oben mit Fett.



### Wiederbefüllung mit Fett bzw. Öl

1. Rondelle entfernen.

2. Antriebskopf herausschrauben (SW 21) und zerlegt ins Batterie-Recycling geben. Nie in der Nähe von offenem Feuer herausschrauben! Anschliessend wie Erstbefüllung mit Fett bzw. Öl.

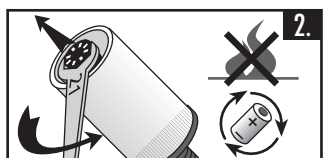

### Hinweis

Um eine zuverlässige Funktion des simalube Schmierstoffgebers sicherstellen zu können, dürfen nur Fette verwendet werden, die für den Gebrauch im simalube geprüft und freigegeben sind. Es ist insbesondere auf eine gute Stabilität des Fettes gegen Ausbluten des Grundöls und auf eine niedrige Konsistenz-Klasse (max. NLGI 2) zu achten.

Bei selbstbefüllten Spendern sowie bei Verwendung von nicht ausdrücklich freigegebenen Schmierstoffen kann keine Gewährleistung in Anspruch genommen werden. Im Zweifelsfall kontaktieren Sie unsere technische Beratung oder Ihren Händler.

## Schmierstoffübersicht

Das Schmierstoffsortiment für den simalube umfasst moderne und erprobte, für die besonderen Anforderungen an Fett- und Ölsperer modifizierte Hochleistungsschmierstoffe. Datenblätter sind online unter: [www.simatec.com](http://www.simatec.com) verfügbar. Bestimmungen/Sicherheitsvorschriften der Fett-/Ölhersteller sind diesen Datenblättern zu entnehmen.

Nr.	Anwendung	Temperaturbereich (in der Schmierzone)
<b>SL01</b>	Universalfett	-30/+120 °C
<b>SL02</b>	Universalfett + MoS <sub>2</sub>	-25/+130 °C
<b>SL04</b>	Hochtemperaturfett	-20/+160 °C
<b>SL06</b>	Fliessfett (EP)	-30/+120 °C
<b>SL09</b>	Biofett	-20/+80/100 °C
<b>SL10</b>	Lebensmittelfett (NSF H1)	-40/+130 °C
<b>SL12</b>	Fliessfett für die Lebensmittelindustrie (NSF H1)	-40/+130 °C
<b>SL14</b>	Kettenöl (EP)	-10/+90 °C
<b>SL15</b>	Hochtemperatur Kettenöl (EP)	-30/+250 °C
<b>SL16</b>	Maschinenöl	-20/+100 °C
<b>SL18</b>	Lebensmittelöl (NSF H1)	-15/+150 °C
<b>SL19</b>	Biokettenöl	-15/+100 °C
<b>SL24</b>	Schmierfett für grossen Temperaturbereich (EP)	-30/+140 °C
<b>SL25</b>	Hochtemperaturfett	-20/+160 °C
<b>SL26</b>	Hochleistungsfett (EP)	-20/+150 °C

simalube ist auch mit anderen Schmierstoffen oder leer lieferbar. Lassen Sie sich beraten. Der Einsatz von simalube mit Ölen verschiedener Viskositäten ist ebenfalls möglich.

### EU-Konformitätserklärung

#### **simatec ag**

Stadthof 2 in CH- 3380 Wangen a. Aare  
erklärt, dass die

Schmierstoffspender vom Typ  
simalube & simalube multipoint  
konstruiert und hergestellt wurden in  
Übereinstimmung mit der

**Richtlinie 2014/34/EU des europäischen  
Parlaments und des Rates zur  
Harmonisierung der Rechtsvorschriften  
der Mitgliedstaaten für Geräte und  
Schutzsysteme zur bestimmungsge-  
mäßigen Verwendung in explosionsge-  
fährdeten Bereichen.**

Folgende Normen kamen zur Anwendung:

**EN 60079-0:2018**  
**EN 60079-11:2012**  
**EN 50303:2000**

Prüf- und Zertifizierungsstellen:

**DEKRA Certification B.V.**  
**NL-6825 MJ Arnhem**  
**Kennnummer: 0344**  
Zertifikat Nr.  
**KEMA 09ATEX0098X**

Wangen a. Aare, den 01.01.2022



Mischa Wyssmann, Geschäftsführer / CEO

Hergestellt durch:

#### **simatec ag**

Stadthof 2, CH-3380 Wangen a. Aare  
[www.simalube.com](http://www.simalube.com)



## Product Specification

Product	Automatic long-term grease and oil lubricator.			
Intended Purpose	simalube automatic lubricators are used on machines and devices of all types. They may be mounted directly or with the aid of special mounting accessories.			
Power generation	Hydrogen gas producing drycell			
Working pressure	Max. 5 bar			
Adjustment	Stepless 1–12 months (for standard conditions)			
Dispensing rate	See table on page 11			
Operating temperature	–20 °C to +55 °C (–4 °F to +131 °F) ambient temperature (Note: grease consistency changes with temperature)			
Operation/Usage	Grease dispenser can be installed in any position, even under water. Attention: do not expose to direct heat.			
Risks/Dangers	Despite careful design the possibility that skin comes into contact with lubricant cannot be totally avoided. The lubricant should be removed immediately with water and recommended solvent.			
Ingress protection	IP68 (dust- and waterproof)			
Usage period	Activation within 2 years of production date			
Stock temperature	Recommended at 20 °C ±5 °C (65 °F ±5 °F)			
	<b>30 ml</b>	<b>60 ml</b>	<b>125 ml</b>	<b>250 ml</b>
Weight full	~82 g	~115 g	~190 g	~335 g
Weight empty	~55 g	~60 g	~75 g	~111 g

simalube has been safety inspected and approved by the following institutions:

- TÜV SÜD Product Service GmbH, Germany, Nr. Z1 16 12 29499 023
- TÜV SÜD Product Service GmbH, Germany, Nr. EX2A 029499 0024
- TÜV SÜD Product Service GmbH, Germany, DE/TPS/QAR20.0016/00
- DEKRA Certification B.V., Netherlands, Nr. KEMA 09ATEX0098X
- DEKRA Certification B.V., Netherlands, Nr. IECEx DEK 20.0032X

### Marking typ 30, 60, 125 ml:

II 1 G Ex ia IIC T6 Ga  
 II 1 D Ex ia IIIC T200 80 °C Da  
 I M1 Ex ia I Ma

### Marking typ 250 ml:

II 1 G Ex ia IIC T4 Ga  
 II 1 D Ex ia IIIC T200 135 °C Da  
 I M1 Ex ia I Ma



**simalube 30**



**simalube 60**



**simalube 125**



**simalube 250**

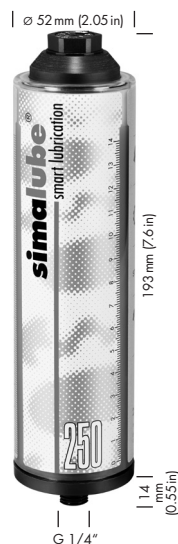

## Assembly and Installation



- 1) Open the lubricator outlet by removing plug.

**Do not remove plug from oil filled units!** Cut off the protruding nipple with a knife; a small black point becomes visible (opening now guaranteed).



- 2) To start the simalube lubricator, set the gas generator to the required dispensing time (stepless in months, 1–12) using a 3 mm allen key. The lubricator is activated once the dispensing time has been set. Take the required dispensing quantity from the tables on page 11.

- 3) Note the starting date on the label using a waterproof pen.



- 4) Clear grease lines and fill them with the appropriate grease. Screw simalube onto the greasing point. If necessary, use accessories shown on page 33–39. Apply safety rules.
- 5) Once the set dispensing time has expired, replace empty lubricator with the same type or refill. Before restarting, clear grease lines and fill them with the appropriate grease.
- 6) The gas generator is sufficient to empty the unit once, **irrespective of the dispensing time set.**

**Security note:** If the lubricator is started without opening the outlet or in case of blocked grease lines within the installation, the pressure in the lubricator can build up approx. 5 bar. At an overpressure of approx. 6 bar the lubricator breaks at the defined breaking point between housing and bottom. The pressure behind the piston releases and oil or grease can come out at the breaking point.



**Warning:** For applications in explosive gas or dust atmospheres, precautions shall be taken to minimize the risk from electrostatic discharge or propagating brush discharges at the product surface. Cleaning of the surface shall be done using a damp cloth.

The correct functioning of the lubricator can only be assured if recommended lubricants (see table on page 14) and original simalube accessories are used, and if the installation, operating and maintenance instructions are closely followed. The manufacturer cannot accept any responsibility for damages as a result of ignoring the instructions mentioned above. **Important:** Before putting simalube into operation, fill extensions and the lubrication lines with the appropriate simalube greases (cartouches SL01 ...SL26) using a grease gun. Use only original accessories.

## Temperature/Output rate

The output rate can be adjusted as required, depending on the ambient temperature (see table).

**Example:** You want to set the dispensing time for a 125 ml simalube for 180 days.

Ambient temperature: 20 °C

Setting: 6

Ambient temperature: 55 °C

Setting: 7



### simalube 30

Dispensing time (days)	30	90	180	270	360
ml/day	1.00	0.33	0.17	0.11	0.08
Temperature	Setting	Setting	Setting	Setting	Setting
-20°C	+	2	3.5	5.5	7.5
4°C	+	2.5	5	7.5	10.5
<b>20°C</b>	<b>1</b>	<b>3</b>	<b>6</b>	<b>9</b>	<b>12</b>
40°C	1	3	6.5	9.5	-
55°C	1	3.5	7	10.5	-

- + Use larger dispenser with longer dispensing time
- Smallest possible output rate reached

### simalube 60

Dispensing time (days)	30	90	180	270	360
ml/day	2.00	0.67	0.33	0.22	0.17
Temperature	Setting	Setting	Setting	Setting	Setting
-20°C	+	2	4	6.5	8
4°C	+	2.5	5.5	9	10.5
<b>20°C</b>	<b>1</b>	<b>3</b>	<b>6</b>	<b>9</b>	<b>12</b>
40°C	1	3	6.5	9.5	-
55°C	1	3.5	7	10.5	-

- + Use larger dispenser with longer dispensing time
- Use smaller dispenser with shorter dispensing time

### simalube 125

Dispensing time (days)	30	90	180	270	360
ml/day	4.17	1.39	0.69	0.46	0.35
Temperature	Setting	Setting	Setting	Setting	Setting
-20°C	+	2	4	6.5	8.5
4°C	+	2.5	5.5	8	10.5
<b>20°C</b>	<b>1</b>	<b>3</b>	<b>6</b>	<b>9</b>	<b>12</b>
40°C	1	3	6.5	9.5	-
55°C	1	3.5	7	10	-

- + Use larger dispenser with longer dispensing time
- Use smaller dispenser with shorter dispensing time

### simalube 250

Dispensing time (days)	30	90	180	270	360
ml/day	8.33	2.78	1.39	0.93	0.69
Temperature	Setting	Setting	Setting	Setting	Setting
-20°C	++	2	4.5	7.5	9.5
4°C	++	2.5	5.5	8	10.5
<b>20°C</b>	<b>1</b>	<b>3</b>	<b>6</b>	<b>9</b>	<b>12</b>
40°C	1	3	6	9	-
55°C	1	3.5	6.5	9.5	-

- ++ Use 2-fold adapter
- Use smaller dispenser with shorter dispensing time

The values relate to laboratory conditions, SL01 with no counterpressure. At low temperatures in particular, the values may vary between one grease type and another. The dispensers must be replaced once the dispensing time set has expired, even if they are not completely empty.

The grease quantity dispensed per day is influenced by:

- counterpressure/resistance from the grease lines
- ambient temperature
- viscosity of the grease

### Start-up time:

The lubricator requires a certain start-up time until the lubricant is first dispensed. The start-up time varies in line with the volume dispensed, dispenser size and operating temperature selected. At 20 °C ambient temperature and a dispensing time setting of 12 months, the dispenser outputs the lubricant within one week. The start-up time doubles at low temperatures (-20 °C) or with small dispensers (30 ml).

You can reduce the start-up time in such a case by setting a dispensing time on the lubricator of one month for one to two days and then changing to the desired dispensing time.

### Free online programs:



Calculation Pro



Lubechart

### simatec app «world of maintenance»:



### Notes:

In order for the unit to function reliably, it is important to have clear, filled grease lines. It must be ensured that the grease lines are not blocked. Consequently, the grease lines should always be cleared with a grease gun before starting.

The simalube can be re-adjusted or switched off during operation. The values on the gas generator relate to laboratory conditions (see page 10). Depending on the temperature and setting, it may take several hours (or several days in the case of long-term settings) until the lubricant is first dispensed. The user must check the operation of the simalube regularly.

Grease lines should be no longer than 0.5 m. Recommended bore diameter: 6–8 mm. Resistance in grease lines has to be minimized, narrow passages and right angles should be avoided. Use a mounting support in the event of strong vibrations or high accelerations (for accessories, see pages 33–39). Use the pressure booster (art. 230.1010) simalube IMPULSE connect with long lubrication lines or high back pressure.

The simalube may only be used to supply **a single** grease point. No branches may be made. Once the lubricator is installed and activated, it must not be removed and mounted onto another lubrication point.

## Recycling Instructions



- 1) Unscrew gas generator and dispose of complete unit for battery recycling (see above). **Note:** Do not detach lubricator near an open flame.
- 2) Dispose of empty housing for plastic recycling. If the lubricator still contains lubricant after use, please dispose of it in accordance with local regulations.

## Filling and Refilling (for small quantities)

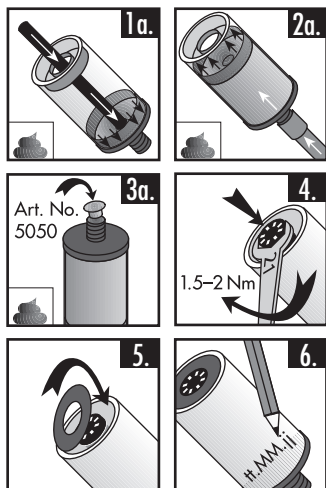

### Filling with grease

- 1a. Push piston all the way forward by blowing gently with compressed air or with the aid of a plastic rod (7 mm diameter), towards the bottom or opening.
- 2a. Screw on refill nipple (Art. 290.3012) and connect grease gun, or screw connector nipple (Art. 290.3013 or 290.3014) onto grease gun. Keep the dispenser pressed to the adapter during the filling process so that you do not have to screw on the refill nipple again. Press grease into the dispenser. Avoid air bubbles when filling the unit. Continue the filling process until the piston has been pushed all the way back. Do not overfill! **Caution: Lever presses can create pressure of up to 80 bar, which is enough to destroy the dispenser.**
- 3a. Use closing nipple if the dispenser is to be stored.

4. Position gas generator (make sure the O-ring is positioned correctly) and attach firmly with a 1.5–2.0Nm torque key.  
**Always use original simalube gas generators.**
5. Clip in cover disk.
6. Note grease type and filling date on the label.

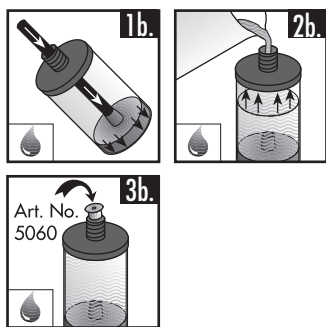

### Filling with oil

- 1b. Push the piston all the way back (towards the gas generator).
- 2b. Pour in oil through the opening at the bottom.
- 3b. Position non-return valve (yellow, Art. 290.5060).
- 4.–6. Continue as above.

### Refilling with grease or oil

1. Remove cover disk.
2. Unscrew gas generator (SW 21) and recycle with other batteries. Never remove near an open flame! Then continue as above for filling with grease or oil.

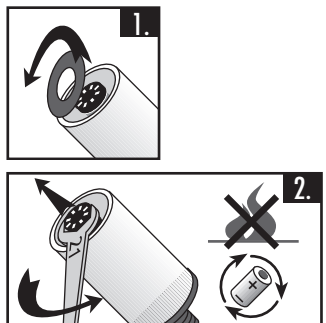

### Note:

To ensure that the simalube lubricator operates reliably, only greases that have been tested and approved for use with the simalube should be used. In particular, it is important to ensure the good stability of the grease against bleeding of the base oil and a low consistency class (max. NLGI 2). No guarantee claims will be accepted when dispensers are filled by the user or not explicitly approved lubricants are used. If in doubt, please contact our technical department or your local distributor.

## Lubricants

The standard lubricant range suitable for simalube includes modern high quality lubricants tested and modified for the special requirements of grease and oil dispensers. Datasheets are available online for all lubricants ([www.simatec.com](http://www.simatec.com)). Please refer to these datasheets for the instructions/safety regulations of the grease/oil manufacturers.

No.	Application	Temperature range (in the area of lubrication)
<b>SL01</b>	Multipurpose grease	-30/+120 °C
<b>SL02</b>	Multipurpose grease with MoS <sub>2</sub>	-25/+130 °C
<b>SL04</b>	High temperature grease	-20/+160 °C
<b>SL06</b>	Fluid grease (EP)	-30/+120 °C
<b>SL09</b>	Biodegradable grease	-20/+80/100 °C
<b>SL10</b>	Food industry grease (NSF H1)	-40/+130 °C
<b>SL12</b>	Very soft food industry grease (NSF H1)	-40/+130 °C
<b>SL14</b>	Chain oil (EP)	-10/+90 °C
<b>SL15</b>	High temperature chain oil (EP)	-30/+250 °C
<b>SL16</b>	Machine oil	-20/+100 °C
<b>SL18</b>	Food industry oil (NSF H1)	-15/+150 °C
<b>SL19</b>	Biodegradable chain oil	-15/+100 °C
<b>SL24</b>	Grease for a wide temperature range (EP)	-30/+140 °C
<b>SL25</b>	High temperature grease	-20/+160 °C
<b>SL26</b>	High performance grease (EP)	-20/+150 °C

simalube can also be delivered filled with other lubricants or as an empty unit. Ask for advice. The operation of simalube with oils of different viscosities is also possible.

### EU Declaration of Conformity

#### simatec ag

Stadthof 2 in CH-3380 Wangen a. Aare  
declares that the

single point lubricators

#### simalube & simalube multipoint

are designed and manufactured in  
accordance with

**Directive 2014/34/EU of the European Parliament and the Council on the harmonisation of the laws of the Member States relating to equipment and protective systems intended for use in potentially explosive atmospheres.**

The following standards have been applied:

**EN 60079-0:2018**

**EN 60079-11:2012**

**EN 50303:2000**

Notified Body:

**DEKRA Certification B.V.**

**NL-6825 MJ Arnhem**

**Identification number: 0344**

Certificate No.

**KEMA 09ATEX0098X**

Wangen a. Aare, 01.01.2022

Mischa Wyssmann, Managing Director / CEO

Manufactured by:

#### simatec ag

Stadthof 2, CH-3380 Wangen a. Aare

[www.simalube.com](http://www.simalube.com)

## Spécifications du produit

Type	Graisser automatique longue durée pour point de lubrification individuel, adapté pour huiles et graisses.			
Spécifications d'utilisation	Les graisseurs automatiques simalube sont installés sur diverses machines et appareils pour la lubrification de composants de tous types. L'installation se fait directement sur celui-ci ou via un large éventail d'accessoires.			
Système de commande	Cellule génératrice de gaz H (élément sec)			
Pression de service	Max. 5 bars			
Réglage	Continu 1-12 mois (en conditions normales)			
Quantité dispensée	Voir tableaux en page 17			
Température ambiante d'utilisation	De -20 °C à +55 °C (de -4 °F à +131 °F) (Note: la consistance de la graisse change avec la température)			
Utilisation	Le graisseur peut être installé dans toutes les positions, même sous l'eau. Attention: ne pas exposer directement à la chaleur.			
Risques/dangers	Un contact avec la peau et du lubrifiant est possible malgré une construction élaborée. Rincer immédiatement avec de l'eau et/ou du détergent.			
Indice de protection	IP68 (antipoussière et imperméable)			
Période d'utilisation	Activation dans les 2 années suivant la date de production			
Température de stockage	Recommandée à 20 °C ±5 °C (65 °F ±5 °F)			
	<b>30 ml</b>	<b>60 ml</b>	<b>125 ml</b>	<b>250 ml</b>
Poids plein	~82 g	~115 g	~190 g	~335 g
Poids vide	~55 g	~60 g	~75 g	~111 g

La sécurité du simalube a été examinée et homologuée par les instituts suivants:

- TÜV SÜD Product Service GmbH, Germany, Nr. Z1 16 12 29499 023
- TÜV SÜD Product Service GmbH, Germany, Nr. EX2A 029499 0024
- TÜV SÜD Product Service GmbH, Germany, DE/TPS/QAR20.0016/00
- DEKRA Certification B.V., Netherlands, Nr. KEMA 09ATEX0098X
- DEKRA Certification B.V., Netherlands, Nr. IECEx DEK 20.0032X

### Étiquetage type 30, 60, 125 ml:

II 1 G Ex ia IIC T6 Ga  
 II 1 D Ex ia IIIC T<sub>200</sub> 80 °C Da  
 I M1 Ex ia I Ma

### Étiquetage type 250 ml:

II 1 G Ex ia IIC T4 Ga  
 II 1 D Ex ia IIIC T<sub>200</sub> 135 °C Da  
 I M1 Ex ia I Ma



#### simalube 30



#### simalube 60



#### simalube 125



#### simalube 250

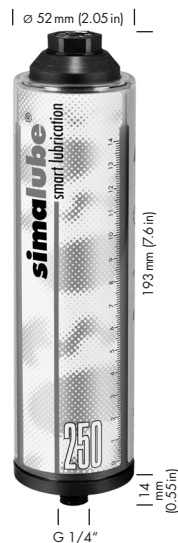

## Montage et mise en service



- 1) Ouvrir la sortie de décharge du lubrifiant en découpant la capsule ou en enlevant le bouchon de fermeture.

**Ne pas enlever le bouchon des graisseurs remplis d'huile!**

Oter la pointe à l'aide d'un couteau. Un petit point noir sera visible, l'ouverture est maintenant garantie.



- 2) Pour que le graisseur simalube soit mis en service, la durée de distribution (continue de 1 à 12 mois) doit être réglée sur la tête de commande à l'aide d'une clé à lèvre (3 mm). A partir du moment où la durée est réglée, le graisseur est activé. Déterminer la quantité de graisse désirée en se référant au tableau en page 17.



- 3) Inscrire la date de la mise en service sur l'étiquette avec un feutre résistant à l'eau.
- 4) Remplir les canaux de graissage à l'aide d'une pompe à graisse. Visser le simalube sur le point de graissage. Si nécessaire, utiliser les accessoires pages 33–39. Respecter la remarque de sécurité.
- 5) Une fois le temps prédéfini écoulé, remplacer le graisseur vide par le même type ou le recharger. Avant de remettre en service, remplir les canaux de graissage à l'aide d'une pompe à graisse.
- 6) La tête de commande est suffisante pour vider **une fois** le simalube, **indépendamment du temps choisi**.

**Remarque de sécurité:** si le simalube est mis en fonction sans enlever le bouchon ou si les canaux de graissage de l'installation sont bouchés, la pression peut s'élever jusqu'à 5 bars environ. A une surpression d'environ 6 bars, le graisseur se fendra entre le boîtier et la base profilée. La pression derrière le piston se relâchera. De l'huile ou de la graisse peuvent s'échapper du point de rupture.



**Avertissement:** Pour les applications dans des atmosphères explosives gazeuses ou poussiéreuses, des précautions doivent être prises pour minimiser le risque de décharge électrostatique ou de propagation des broussailles à la surface du produit. Le nettoyage de la surface doit être effectué à l'aide d'un chiffon humide.

Le fonctionnement correct du graisseur n'est optimal qu'avec l'utilisation des graisses recommandées (aperçu p. 20), des accessoires originaux simalube et l'observation des instructions de montage, d'opération et de maintenance. En cas de non-observation de ces instructions, le fabricant refuse toute responsabilité pour les dommages conséquents.

**Important:** avant la mise en service de simalube, remplir les rallonges et les conduites de graissage avec le type de graisse simalube approprié (cartouches SL01...SL26) au moyen d'une pompe à graisse. N'utiliser que des accessoires originaux simalube.

## Température/Compensation des quantités distribuées

Au besoin, la quantité dispensée peut être adaptée en continu suivant la température ambiante (voir tableau).

**Exemple:** le temps désiré pour un simalube 125 ml est de 180 jours.

Température: 20 °C

Réglage: 6

Température ambiante: 55 °C

Réglage: 7





### simalube 30

Durée (jours)	30	90	180	270	360
ml/jour	1,00	0,33	0,17	0,11	0,08
Température	Réglage	Réglage	Réglage	Réglage	Réglage
-20°C	+	2	3.5	5.5	7.5
4°C	+	2.5	5	7.5	10.5
<b>20°C</b>	<b>1</b>	<b>3</b>	<b>6</b>	<b>9</b>	<b>12</b>
40°C	1	3	6.5	9.5	-
55°C	1	3.5	7	10.5	-

- + Utiliser un graisseur plus grand avec une durée supérieure
- Plus petite quantité de graissage possible obtenue

### simalube 60

Durée (jours)	30	90	180	270	360
ml/jour	2,00	0,67	0,33	0,22	0,17
Température	Réglage	Réglage	Réglage	Réglage	Réglage
-20°C	+	2	4	6.5	8
4°C	+	2.5	5.5	9	10.5
<b>20°C</b>	<b>1</b>	<b>3</b>	<b>6</b>	<b>9</b>	<b>12</b>
40°C	1	3	6.5	9.5	-
55°C	1	3.5	7	10.5	-

- + Utiliser un graisseur plus grand avec une durée supérieure
- Utiliser un graisseur plus petit avec une durée inférieure

### simalube 125

Durée (jours)	30	90	180	270	360
ml/jour	4,17	1,39	0,69	0,46	0,35
Température	Réglage	Réglage	Réglage	Réglage	Réglage
-20°C	+	2	4	6.5	8.5
4°C	+	2.5	5.5	8	10.5
<b>20°C</b>	<b>1</b>	<b>3</b>	<b>6</b>	<b>9</b>	<b>12</b>
40°C	1	3	6.5	9.5	-
55°C	1	3.5	7	10	-

- + Utiliser un graisseur plus grand avec une durée supérieure
- Utiliser un graisseur plus petit avec une durée inférieure

### simalube 250

Durée (jours)	30	90	180	270	360
ml/jour	8,33	2,78	1,39	0,93	0,69
Température	Réglage	Réglage	Réglage	Réglage	Réglage
-20°C	++	2	4.5	7.5	9.5
4°C	++	2.5	5.5	8	10.5
<b>20°C</b>	<b>1</b>	<b>3</b>	<b>6</b>	<b>9</b>	<b>12</b>
40°C	1	3	6	9	-
55°C	1	3.5	6.5	9.5	-

- ++ Utiliser un adaptateur double
- Utiliser un graisseur plus petit avec une durée inférieure

Ces valeurs se réfèrent à des conditions de laboratoire, SL01, décharge libre. Surtout à des températures basses, les valeurs peuvent varier selon les types de graisse. Une fois le temps choisi écoulé, les graisseurs doivent être remplacés même s'ils ne sont pas entièrement vidés.

La quantité de graisse distribuée par jour est influencée par:

- la résistance/contre-pression dans les conduites
- la température ambiante
- la viscosité des graisses

### Temps de démarrage:

Le graisseur requiert un temps de démarrage avant la première sortie de lubrifiant. Ce temps varie en fonction du réglage, de la taille du graisseur et de la température ambiante. A une température ambiante de 20 °C et pour une durée réglée sur 12 mois, le graisseur fournit le lubrifiant en une semaine. A des températures basses (-20 °C) ou dans le cas de graisseurs de petite taille (30 ml), ce temps de démarrage est deux fois plus long.

Pour réduire le temps de démarrage il est possible de régler la durée sur un mois pendant un ou deux jours avant de sélectionner la durée initialement souhaitée.

### Logiciels en ligne gratuits:



Calculation Pro



Lubechart

### appli simatec «world of maintenance»:



### Remarques:

Pour un fonctionnement fiable, il est indispensable que les canaux de graissage soient remplis et qu'ils ne soient pas bouchés. Il faut donc les remplir à l'aide d'une pompe à graisse avant toute mise en service du graisseur.

Le simalube peut être réglé ou arrêté pendant le fonctionnement. Les valeurs indiquées sur le disque de réglage se réfèrent aux conditions de laboratoire (voir p. 16). La sortie du lubrifiant dépend du réglage et de la température. Elle peut avoir lieu quelques heures ou, pour les réglages longue durée, quelques jours après la mise en service. L'utilisateur doit contrôler régulièrement le fonctionnement du simalube. Les conduites de raccordement ne devraient pas dépasser 50 cm et le diamètre intérieur préconisé est de 6-8 mm. Une friction trop importante dans les conduites doit être évitée. Les étranglements et les condés anguleux ne sont pas tolérés. En cas de vibrations intenses ou de fortes accélérations, utiliser le support de montage (accessoires, p. 33-39). Avec de longues tubes ou avec une pression élevée utilisez l'amplificateur de pression simalube IMPULSE connect (Art. 230.1010).

Le simalube ne doit être utilisé que pour l'alimentation **d'un seul** point de graissage. Ne pas créer de ramifications. Dès que le graisseur est installé et activé il ne peut plus être dévissé ni être monté sur un autre point de graissage.

## Instructions de recyclage



- 1) Dévisser la tête de commande (21 mm) et la remettre, sans la démonter, au recyclage des batteries. **Remarque:** Ne jamais la dévisser à proximité d'une flamme.
- 2) Remettre le boîtier vide au recyclage des plastiques. Si le graisseur contient encore de la graisse après l'usage, celle-ci est à éliminer d'après les standards locaux.

## Remplissage manuel et recharge (petites quantités)

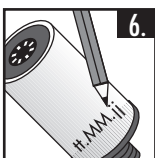
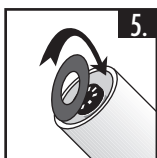
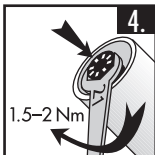
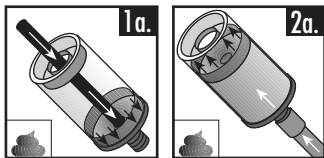

### Premier remplissage avec de la graisse

- 1a. Pousser le piston complètement vers le bas par un léger soufflage d'air comprimé ou à l'aide d'une tige en plastique (diamètre 7 mm), vers la base profilée (la sortie de décharge).
- 2a. Visser le graisseur de recharge (Art. 290.3012) et raccorder la pompe à graisse, ou visser le raccord (Art. 290.3013 ou 290.3014) sur la pompe à graisse. Cette procédure de remplissage évite le vissage répété des graisseurs simalube. Maintenir le graisseur appuyé contre le raccord et commencer le remplissage. Eviter la formation de bulles pendant le remplissage. Continuer à remplir jusqu'à ce que le piston soit bien en butée arrière. Ne pas surcharger! **Attention: les presses à levier peuvent générer une pression de 80 bars susceptible de détruire le graisseur!**
- 3a. Si le graisseur doit être stocké mettre le bouchon de fermeture.

4. Poser la tête de commande (vérifier que le joint torique est bien ajusté) et serrer à 1,5–2,0 Nm avec la clé dynamométrique.

**N'utiliser que les cellules originales simalube.**

5. Encliqueter la rondelle.
6. Noter sur l'étiquette le nom de la graisse et la date de remplissage.

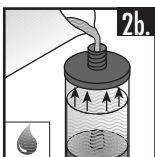
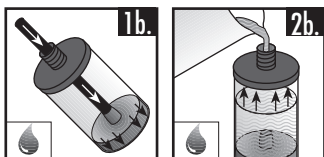

### Premier remplissage avec de l'huile

- 1b. Pousser le piston complètement vers le haut (vers la tête de commande).
- 2b. Verser l'huile par l'ouverture de la base profilée.
- 3b. Poser le bouchon antiretour (jaune, Art. 290.5060).
- 4.–6. Procéder comme décrit ci-dessus.

### Recharge avec de la graisse ou de l'huile

1. Enlever la rondelle.
2. Dévisser la tête de commande (21 mm) et la remettre, sans la démonter, au recyclage des piles. Ne jamais la dévisser à proximité d'une flamme! Ensuite, procéder comme pour un premier remplissage avec de la graisse ou de l'huile.

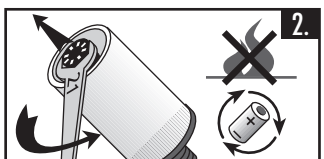

### Remarque:

Pour garantir un fonctionnement fiable du graisseur, n'utiliser que des graisses testées et autorisées pour un usage avec le simalube. Il faut notamment veiller à une bonne stabilité de la graisse par rapport au ressuage de l'huile de base et à une classe de consistance d'un maximum NLGI 2. En cas de doute, veuillez contacter notre service technique ou votre distributeur.

## Aperçu des lubrifiants

L'assortiment de lubrifiants pour le simalube comprend des lubrifiants modernes, approuvés très performants et adaptés aux exigences particulières des graisseurs simalube. Vous pouvez obtenir les fiches techniques de toutes les graisses chez leurs fabricants respectifs (en ligne sur: [www.simatec.com](http://www.simatec.com)). Ces fiches contiennent les conditions et les directives de sécurité établies par les fabricants de lubrifiants.

N°	Application	Plage des températures (zone de graissage)
<b>SL01</b>	Graisse universelle	-30/+120 °C
<b>SL02</b>	Graisse universelle + MoS <sub>2</sub>	-25/+130 °C
<b>SL04</b>	Graisse pour hautes températures	-20/+160 °C
<b>SL06</b>	Graisse fluide (EP)	-30/+120 °C
<b>SL09</b>	Graisse biodégradable	-20/+80/100 °C
<b>SL10</b>	Graisse pour l'industrie alimentaire (NSF H1)	-40/+130 °C
<b>SL12</b>	Graisse semi-fluide alimentaire (NSF H1)	-40/+130 °C
<b>SL14</b>	Huile pour chaînes (EP)	-10/+90 °C
<b>SL15</b>	Huile pour chaînes hautes températures (EP)	-30/+250 °C
<b>SL16</b>	Huile pour machines	-20/+100 °C
<b>SL18</b>	Huile pour l'industrie alimentaire (NSF H1)	-15/+150 °C
<b>SL19</b>	Huile biodégradable pour chaînes	-15/+100 °C
<b>SL24</b>	Graisse à plage de températures étendues (EP)	-30/+140 °C
<b>SL25</b>	Graisse haute température	-20/+160 °C
<b>SL26</b>	Graisse haute performance (EP)	-20/+150 °C

Le simalube peut être livré vide ou avec d'autres lubrifiants. Demandez conseil. Le simalube peut également être utilisé avec des huiles de viscosités différentes.

### Déclaration UE de conformité

#### **simatec ag**

Stadthof 2 in CH-3380 Wangen a. Aare  
confirme, que les

graisseurs du type

#### **simalube & simalube multipoint**

ont été construits et fabriqués en  
concordance avec la

**Directive 2014/34/CE du Parlement  
européen et du Conseil relative à  
l'harmonisation des législations des  
États membres concernant les appareils  
et les systèmes de protection destinés à  
être utilisés en atmosphères explosibles.**

Normes appliquées:

**EN 60079-0:2018**  
**EN 60079-11:2012**  
**EN 50303:2000**

Certification:

**DEKRA Certification B.V.**  
**NL-6825 MJ Arnhem**  
**Numéro d'identification: 0344**

Certificat n°

**KEMA 09ATEX0098X**

Wangen a. Aare, 01.01.2022



Mischa Wyssmann, Directeur Général / CEO

Produit par:

**simatec ag**

Stadthof 2, CH-3380 Wangen a. Aare  
[www.simalube.com](http://www.simalube.com)

## Especificaciones del producto

Producto	Lubricador automático de larga duración para aceite y grasa			
Uso previsto	El dispensador automático de lubricante simalube se utiliza en maquinaria y máquinas para lubricación de componentes de cualquier tipo. La lubricación se realiza directamente o través de accesorios especialmente diseñados.			
Sistema de suministro	H2 (elemento seco)			
Presión de trabajo	5 bar máximo			
Regulación	Continua, 1 a 12 meses (en condiciones normales)			
Cantidad dispensada	Ver tabla en página 23			
Temperatura de operación	Temperatura ambiente desde -20 °C a +55 °C (Nota: la consistencia de la grasa cambia con la temperatura)			
Operación/Uso	El lubricador puede ser instalado en cualquier posición, incluso bajo el agua. Atención: no debe exponerse a calor directo.			
Riesgos/Peligros	A pesar del diseño cuidadoso, puede ocurrir contacto con la piel y el lubricante. Esto debe eliminarse inmediatamente por medio de agua/detergente.			
Grado de protección	IP68 (protección total contra el polvo y contra los efectos de inmersión prolongada)			
Período de uso	Activar dentro 2 años desde la fecha de fabricación			
Temperatura de almacenamiento	Recomendado a una temperatura de 20 °C ±5 °C			
	<b>30 ml</b>	<b>60 ml</b>	<b>125 ml</b>	<b>250 ml</b>
Peso lleno	~82 g	~115 g	~190 g	~335 g
Peso vacío	~55 g	~60 g	~75 g	~111 g

Ha sido probado y aprobado por las siguientes instituciones:

- TÜV SÜD Product Service GmbH, Germany, Nr. Z1 16 12 29499 023
- TÜV SÜD Product Service GmbH, Germany, Nr. EX2A 029499 0024
- TÜV SÜD Product Service GmbH, Germany, DE/TPS/QAR20.0016/00
- DEKRA Certification B.V., Netherlands, Nr. KEMA 09ATEX0098X
- DEKRA Certification B.V., Netherlands, Nr. IECEx DEK 20.0032X

### Etiquetado tipo 30, 60, 125 ml:

II 1 G Ex ia IIC T6 Ga  
II 1 D Ex ia IIIC T200 80 °C Da  
I M1 Ex ia I Ma

### Etiquetado tipo 250 ml:

II 1 G Ex ia IIC T4 Ga  
II 1 D Ex ia IIIC T200 135 °C Da  
I M1 Ex ia I Ma



#### simalube 30



#### simalube 60



#### simalube 125



#### simalube 250

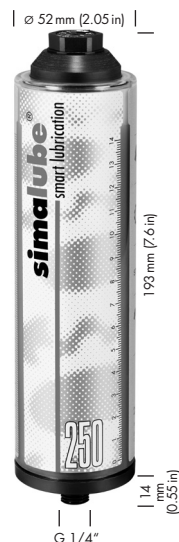

## Montaje y puesta en operación



- 1) Abra la salida del lubricador retirando el tapón.

**No remueva el tapón de las unidades cargadas con aceite.** Corte el niple sobresaliente con un cuchillo; un pequeño agujero negro se hace visible (ahora está garantizada la apertura).



- 2) Para iniciar el lubricador simalube regule el tiempo de descarga (en meses seleccionable de forma progresiva entre 1-12) en la celda generadora mediante una llave Allen (SW3). El lubricador está activado cuando se ha ajustado el tiempo de descarga. Consulte la cantidad dispensada deseada en las tablas (p. 23).



- 3) Con un lápiz indeleble anote la fecha de puesta en marcha en la etiqueta.
- 4) Engrase las líneas de lubricación con la graser. Atornille el simalube en el punto de engrase. Si fuera necesario utilice el accesorio p. 33-39. Tenga en cuenta la advertencia de seguridad.
- 5) Una vez finalizado el tiempo seleccionado, reemplace el lubricador vacío por uno igual o rellénelo. Antes de ponerlo en operación, lubrique las líneas de grasa con la graser.
- 6) La celda generadora es suficiente para una descarga, **independientemente del tiempo de descarga seleccionado.**

**Advertencia de seguridad:** Si el lubricador es iniciado sin abrir la salida o en caso de líneas de grasa obstruidas en la instalación, la presión en el lubricador puede subir hasta 5 bar. Con una sobre presión de aproximadamente 6 bar el lubricador se revienta en el punto de ruptura predefinido, entre el manto y el fondo. La presión detrás del pistón se anula y algo de aceite o grasa puede salir por la rotura.



**Advertencia:** Para aplicaciones en atmósferas explosivas de gas o polvo, se deben tomar precauciones para minimizar el riesgo de descargas electrostáticas o descargas del cepillo de propagación en la superficie del producto. La limpieza de la superficie se realizará con un paño húmedo.

El funcionamiento correcto del lubricador solo se puede asegurar si se usan los lubricantes recomendados (ver tabla en página 26) y los accesorios originales simalube y si se siguen fielmente las instrucciones de instalación, operación y mantenimiento. El fabricante no puede aceptar ninguna responsabilidad por daños causados por no seguir dichas instrucciones. **Importante:** antes de poner los simalube en operación, llene todas las extensiones y tuberías de lubricación con la grasa simalube adecuadas (cartuchos SL01... SL26) usando una graser. Use solo accesorios originales.

## Temperatura, compensación de la cantidad entregada

La cantidad dispensada puede adaptarse progresivamente en función de la temperatura ambiente (comp. tabla).

**Ejemplo:** El tiempo de descarga deseado para un simalube 125 ml es de 180 días.

Temperatura ambiente: 20 °C  
Ajuste: 6

Temperatura ambiente: 55 °C  
Ajuste: 7



### simalube 30

Tiempo de descarga (días)	30	90	180	270	360
ml/día	1,00	0,33	0,17	0,11	0,08
Temperatura	Ajuste	Ajuste	Ajuste	Ajuste	Ajuste
-20°C	+	2	3.5	5.5	7.5
4°C	+	2.5	5	7.5	10.5
<b>20°C</b>	<b>1</b>	<b>3</b>	<b>6</b>	<b>9</b>	<b>12</b>
40°C	1	3	6.5	9.5	-
55°C	1	3.5	7	10.5	-

- + Utilice lubricadores de mayor tamaño con mayores tiempos de descarga
- Mínima cantidad dispensada posible de alcanzar

### simalube 60

Tiempo de descarga (días)	30	90	180	270	360
ml/día	2,00	0,67	0,33	0,22	0,17
Temperatura	Ajuste	Ajuste	Ajuste	Ajuste	Ajuste
-20°C	+	2	4	6.5	8
4°C	+	2.5	5.5	9	10.5
<b>20°C</b>	<b>1</b>	<b>3</b>	<b>6</b>	<b>9</b>	<b>12</b>
40°C	1	3	6.5	9.5	-
55°C	1	3.5	7	10.5	-

- + Utilice lubricadores de mayor tamaño con mayores tiempos de descarga
- Utilizar un lubricador mas pequeño con tiempo de descarga menor

### simalube 125

Tiempo de descarga (días)	30	90	180	270	360
ml/día	4,17	1,39	0,69	0,46	0,35
Temperatura	Ajuste	Ajuste	Ajuste	Ajuste	Ajuste
-20°C	+	2	4	6.5	8.5
4°C	+	2.5	5.5	8	10.5
<b>20°C</b>	<b>1</b>	<b>3</b>	<b>6</b>	<b>9</b>	<b>12</b>
40°C	1	3	6.5	9.5	-
55°C	1	3.5	7	10	-

- + Utilice lubricadores de mayor tamaño con mayores tiempos de descarga
- Utilizar un lubricador mas pequeño con tiempo de descarga menor

### simalube 250

Tiempo de descarga (días)	30	90	180	270	360
ml/día	8,33	2,78	1,39	0,93	0,69
Temperatura	Ajuste	Ajuste	Ajuste	Ajuste	Ajuste
-20°C	++	2	4.5	7.5	9.5
4°C	++	2.5	5.5	8	10.5
<b>20°C</b>	<b>1</b>	<b>3</b>	<b>6</b>	<b>9</b>	<b>12</b>
40°C	1	3	6	9	-
55°C	1	3.5	6.5	9.5	-

- ++ Utilice el adaptador doble
- Utilice lubricadores pequeños con tiempos de descarga menores

Los valores se refieren a condiciones de laboratorio, SL01 sin contrapresión. Sobre todo a bajas temperaturas, los valores pueden variar según las diferentes grasas. Los lubricadores deben ser reemplazados al finalizar el tiempo ajustado aunque no estén completamente vacíos.

La cantidad de grasa suministrada diariamente es influenciada por:

- contrapresión/resistencia de los ductos (cañerías)
- temperatura ambiente
- viscosidad de la grasa

### Tiempo de arranque:

El lubricador necesita un tiempo de arranque hasta el comienzo de la salida del lubricante. Este tiempo de arranque varía según la cantidad dispensada seleccionada, el tamaño del lubricador y la temperatura de funcionamiento. A una temperatura ambiente de 20 °C y un ajuste del tiempo de descarga de 12 meses, la grasa tarda una semana en salir. Con temperaturas más bajas (-20 °C) o lubricadores más pequeños (30 ml), el tiempo de descarga se duplica.

En estos casos es posible reducir el tiempo de descarga ajustando el lubricador durante 1 o 2 días a un mes y cambiando después al tiempo deseado.

### Programas gratuitos en línea:

### Aplicación simatec «simatec world of maintenance»:



Calculation Pro



Lubechart



### Notas:

Para un funcionamiento confiable es indispensable que los ductos (cañerías) de engrase estén completamente llenos de lubricante. Es necesario asegurarse de que no estén obstruidos. Por eso, deben ser prelubricados con una grasera antes de la puesta en marcha de los lubricadores. El simalube puede ser regulado o detenido durante su operación. Los valores indicados en el disco de regulación son en relación a las condiciones de laboratorio (véase la página 22). El comienzo de salida de lubricante depende de las regulaciones y de la temperatura, y puede tardar desde algunas horas hasta algunos días. El usuario debe controlar regularmente el funcionamiento del simalube. Los ductos de engrase no deben exceder los 0,5 m de longitud. Se recomienda un diámetro interior de 6–8 mm. No está permitida la resistencia en los ductos, estrechamientos ni ángulos rectos. En caso de vibraciones o aceleraciones fuertes se recomienda usar un soporte de montaje (Accesorios p. 33–39). Utilice el amplificador de presión simalube IMPULSE connect (Art. 230.1010) con conductos de lubricación largos o de alta resistencia. El simalube sólo puede usarse para el suministro de **un solo** punto de engrase. No están permitidas salidas múltiples. Una vez instalado y activado el lubricador, no se puede quitar montar en otro punto.

## Instrucciones para el reciclaje



- 1) Desatornille la celda generadora de gas y deseche la unidad completa en un basurero para reciclaje de baterías (ver mas arriba). **Nota:** No retire el lubricador cerca de una llama abierta.
- 2) Descarte el recipiente vacío para reciclaje de plástico. Si todavía contiene lubricante, descártelo de acuerdo con los reglamentos locales.



## Carga y recarga (para pequeñas cantidades)

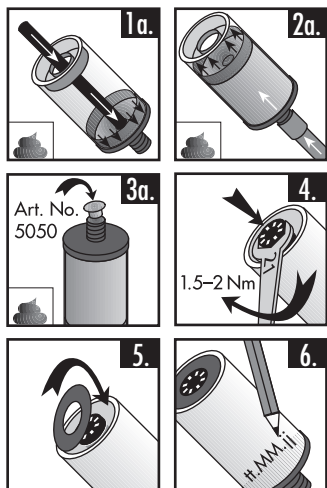

### Primera carga con grasa

- 1a. Aplicando un ligero chorro de aire a presión o con la ayuda de una varilla de plástico (diámetro 7 mm), deslice el émbolo completamente hacia abajo, en dirección al embudo o al orificio de salida.
- 2a. Atornille el racor de recarga (Art. 290.3012) o utilice el adaptador (Art. 290.3013 o 290.3014) y conecte la pistola de engrase. Controlar que durante el llenado no se formen burbujas de aire. Continúe con la recarga hasta que el émbolo esté completamente arriba. ¡No llene en exceso! **¡Atención: la presión de pistola de engrase podrá alcanzar 80 bar, ¡suficiente para romper el lubricador!**
- 3a. Si no va a utilizar el lubricador durante el tiempo, coloque el tapón de cierre (Art. 290.5050).
4. Instale la celda generadora (asegúrese de que el O-ring está colocado correcta-

mente) y apriétela con una llave de carraca con un torque de 1,5-2,0 Nm.

**Utilice siempre cabezales de unidad de simalube originales.**

5. Instale el disco de protección.
6. Anote el nombre de la grasa y la fecha de llenado en la etiqueta.

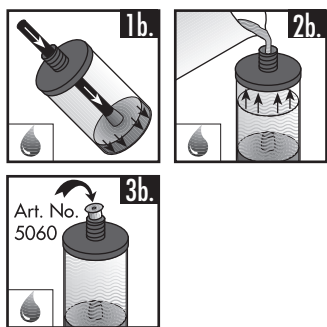

### Primera carga con aceite

- 1b. Deslice el émbolo completamente hacia atrás (hacia la celda generadora).
- 2b. Rellene el aceite a través del orificio del embudo.
- 3b. Coloque el tapón de la válvula de retención (amarillo, Art. 290.5060).
- 4.-6. Mismos pasos que en llenado con grasa.

### Recarga con grasa o aceite

1. Retire el disco de protección.
2. Desatornille la celda generadora (SW 21) y descarte la celda completa en el sistema de reciclaje de baterías. ¡No la desatornille nunca cerca de una llama abierta! Continúe como en la primera carga con grasa o aceite.

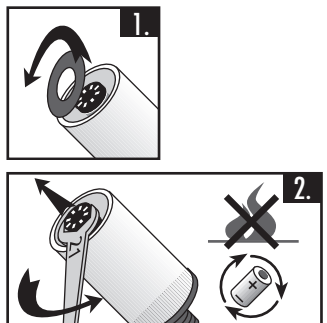

### Nota:

Para poder garantizar un funcionamiento confiable del lubricador simalube, sólo se pueden usar grasas probadas y autorizadas para su empleo en el simalube. Es importante asegurarse de que la estabilidad de la grasa contra el sangrado del aceite base es buena y de que la clase de consistencia es baja (máx. NLGI 2). Quedan fuera de la garantía los lubricadores autorrecargados y el uso de lubricantes no autorizados expresamente. En caso de duda, póngase en contacto con la asistencia técnica o con su distribuidor local.

## Lubricantes

El rango estándar de lubricantes adecuados para los simalube incluye lubricantes modernos de alta calidad probados y modificados para los requerimientos especiales de los dispensadores de grasas y aceites. Hay disponibles fichas técnicas para todas las grasas (online en: [www.simatec.com](http://www.simatec.com)). Cualquier indicación o instrucción de seguridad emitida por los fabricantes de las grasas y aceites estará contenida en estas fichas técnicas.

No.	Aplicación	Rango de temperaturas en el área de lubricación
<b>SL01</b>	Grasa universal multiusos	-30/+120 °C
<b>SL02</b>	Grasa universal multiusos con MoS <sub>2</sub>	-25/+130 °C
<b>SL04</b>	Grasa para alta temperatura	-20/+160 °C
<b>SL06</b>	Grasa fluida resistente al agua (EP)	-30/+120 °C
<b>SL09</b>	Grasa biodegradable	-20/+80/100 °C
<b>SL10</b>	Grasa para industria alimentaria (NSF H1)	-40/+130 °C
<b>SL12</b>	Grasa fluida para industria alimentaria (NSF H1)	-40/+130 °C
<b>SL14</b>	Aceite para cadenas (EP)	-10/+90 °C
<b>SL15</b>	Aceite para cadenas, alta temperatura (EP)	-30/+250 °C
<b>SL16</b>	Aceite de máquina	-20/+100 °C
<b>SL18</b>	Aceite para alimentación (NSF H1)	-15/+150 °C
<b>SL19</b>	Aceite biodegradable para cadenas	-15/+100 °C
<b>SL24</b>	Grasa para amplio rango de temperaturas (EP)	-30/+140 °C
<b>SL25</b>	Grasa para alta temperatura	-20/+160 °C
<b>SL26</b>	Grasa de alto rendimiento (EP)	-20/+150 °C

Los simalube también pueden entregarse llenos con otros lubricantes o como unidades vacías. Solicite más información. También es posible la operación de los simalube con aceites de distintas viscosidades.

### Declaración UE de Conformidad

**simatec ag**

Stadthof 2 in CH-3380 Wangen a. Aare  
 Declara que los

lubricadores a al punto

**simalube & simalube multipoint**

están diseñados y fabricados de acuerdo con la

**Directiva 2014/34/UE del Parlamento Europeo y del Consejo sobre la armonización de las legislaciones de los Estados miembros en materia de aparatos y sistemas de protección para uso en atmósferas potencialmente explosivas.**

Las siguientes normas han sido aplicadas:

**EN 60079-0:2018**

**EN 60079-11:2012**

**EN 50303:2000**

Organismo notificado:

**DEKRA Certification B.V.**

**NL-6825 MJ Arnhem**

**Número de identificación: 0344**

Certificado No.

**KEMA 09ATEX0098X**

Wangen a. Aare, el 01.01.2022

Mischa Wyssmann, Director Ejecutivo / CEO

Distribución para:

**simatec ag**

Stadthof 2, CH-3380 Wangen a. Aare  
[www.simalube.com](http://www.simalube.com)

## Specifiche del prodotto

Prodotto	Lubrificatore automatico a lunga durata per oli e grassi			
Destinazione d'uso	I lubrificatori automatici simalube vengono usati su macchine ed impianti per la lubrificazioni di tutti i tipi componenti. L'installazione viene fatta direttamente oppure tramite appositi accessori.			
Sistema di erogazione	Cellula generatrice di gas H <sub>2</sub> (elemento secco)			
Pressione	Max. 5 bar			
Regolazione	Continua 1-12 mesi (in condizioni normali)			
Quantità erogata	Vedere tabella a pagina 29			
Temperatura di utilizzo	-20 °C ... +55 °C (-4 °F ... +131 °F) temperatura ambiente (Nota: la consistenza del grasso cambia con la temperatura)			
Utilizzo	Il lubrificatore può essere installato in qualsiasi posizione, anche in acqua. Attenzione: non esporre direttamente al calore.			
Rischi/pericoli	Nonostante la costruzione precisa e scrupolosa, potrebbe esserci un contatto del lubrificante con la pelle. Nel caso, rimuovere immediatamente con acqua/detersivo.			
Grado di protezione	IP68 (antipolvere ed impermeabile)			
Periodo d'utilizzo	Attivare entro 2 anni della data di fabbricazione			
Temperatura di stoccaggio	Raccomandata 20 °C ±5 °C (65 °F ±5 °F)			
	<b>30 ml</b>	<b>60 ml</b>	<b>125 ml</b>	<b>250 ml</b>
Peso pieno	~82 g	~115 g	~190 g	~335 g
Peso vuoto	~55 g	~60 g	~75 g	~111 g

simalube è stato testato e approvato dai seguenti enti:

- TÜV SÜD Product Service GmbH, Germany, Nr. Z1 16 12 29499 023
- TÜV SÜD Product Service GmbH, Germany, Nr. EX2A 029499 0024
- TÜV SÜD Product Service GmbH, Germany, DE/TPS/QAR20.0016/00
- DEKRA Certification B.V., Netherlands, Nr. KEMA 09ATEX0098X
- DEKRA Certification B.V., Netherlands, Nr. IECEx DEK 20.0032X

### Etichettatura tipo 30, 60, 125 ml:

II 1 G Ex ia IIC T6 Ga  
 II 1 D Ex ia IIIC T200 80 °C Da  
 I M1 Ex ia I Ma

### Etichettatura tipo 250 ml:

II 1 G Ex ia IIC T4 Ga  
 II 1 D Ex ia IIIC T200 135 °C Da  
 I M1 Ex ia I Ma



#### simalube 30



#### simalube 60



#### simalube 125



#### simalube 250

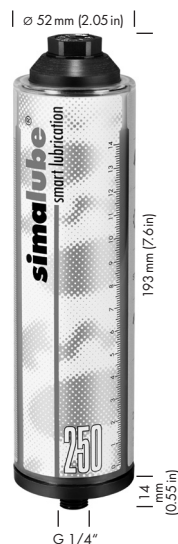

## Montaggio e messa in opera



- 1) Rimuovere il tappo.

**Non togliere il tappo (giallo) dai lubrificatori riempiti con olio!** Tagliare solamente l'estremità del beccuccio: l'apertura diventerà visibile.



- 2) Per avviare il lubrificatore automatico simalube viene impostata la durata dell'erogazione (è possibile una selezione continua in mesi tra 1 e 12) sulla testa di comando tramite la chiave a brugola (SW3). Una volta impostata la durata dell'erogazione, il lubrificatore è attivato. Per una corretta regolazione, vedere i diagrammi a pag. 29.



- 3) Annotare la data di installazione sull'etichetta con inchiostro indelebile.

- 4) Lubrificare i condotti di ingrassaggio con una pompa a grasso e avvitare il simalube sul punto di ingrassaggio. Se necessario, utilizzare gli accessori riportati alle pagine 33-39. Rispettare le avvertenze.

- 5) Una volta trascorsa la durata preselezionata, sostituire il lubrificatore automatico con un altro dello stesso tipo oppure ricaricarlo. Prima di utilizzarlo nuovamente, lubrificare i condotti di ingrassaggio con una pompa a grasso.

- 6) La testa di comando è sufficiente per **un** svuotamento, **a prescindere dalla durata impostata.**

**Avvertenze:** Se il lubrificatore viene attivato senza previa apertura o in caso di ostruzione dei condotti di ingrassaggio, la pressione nel lubrificatore può raggiungere circa 5 bar. Una pressione superiore a 6 bar provocherà una spaccatura tra il contenitore e la calotta con la possibile fuoriuscita di olio o grasso.



**Attenzione:** Per applicazioni in aree esplosive di gas o polvere, delle precauzioni devono essere prese per minimizzare il rischio di una scarica elettrostatica o propagandosi scariche spazzole sulla superficie del prodotto. Pulire la superficie usando un panno umido.

Si garantisce il corretto funzionamento del lubrificatore solo se verranno utilizzati i grassi consigliati (vedi tabella a pag. 32), gli accessori originali e se verranno seguite le istruzioni di montaggio e manutenzione. Qualora le istruzioni non vengano seguite, il produttore declina ogni responsabilità per eventuali danni.

**Importante:** prima di attivare il simalube riempire le prolunghe e i condotti di ingrassaggio con il tipo di grasso simalube appropriato (cartucce SL01...SL26) utilizzando la pompa a grasso. Usare solo gli accessori originali.

## Temperature, compensazione delle quantità

Se necessario, è possibile modificare continuamente la quantità erogata a seconda della temperatura ambiente (vedi diagramma).

**Esempio:** la durata desiderata per un simalube da 125 ml è di 180 giorni.

Temperatura ambiente: 20 °C  
Regolazione: 6



Temperatura ambiente: 55 °C  
Regolazione: 7



**simalube 30**

Durata (giorni)	30	90	180	270	360
ml/giorno	1,00	0,33	0,17	0,11	0,08
Temperatura	Regolazi- one	Regolazi- one	Regolazi- one	Regolazi- one	Regolazi- one
-20°C	+	2	3.5	5.5	7.5
4°C	+	2.5	5	7.5	10.5
<b>20°C</b>	<b>1</b>	<b>3</b>	<b>6</b>	<b>9</b>	<b>12</b>
40°C	1	3	6.5	9.5	-
55°C	1	3.5	7	10.5	-

+ Utilizzare lubrificatori di dimensioni maggiori e dalla maggiore durata

- È stata raggiunta la quantità erogata minima possibile

**simalube 60**

Durata (giorni)	30	90	180	270	360
ml/giorno	2,00	0,67	0,33	0,22	0,17
Temperatura	Regolazi- one	Regolazi- one	Regolazi- one	Regolazi- one	Regolazi- one
-20°C	+	2	4	6.5	8
4°C	+	2.5	5.5	9	10.5
<b>20°C</b>	<b>1</b>	<b>3</b>	<b>6</b>	<b>9</b>	<b>12</b>
40°C	1	3	6.5	9.5	-
55°C	1	3.5	7	10.5	-

+ Utilizzare lubrificatori di dimensioni maggiori e dalla maggiore durata

- Utilizzare un lubrificatore di dimensione minore e dalle minore durata

**simalube 125**

Durata (giorni)	30	90	180	270	360
ml/giorno	4,17	1,39	0,69	0,46	0,35
Temperatura	Regolazi- one	Regolazi- one	Regolazi- one	Regolazi- one	Regolazi- one
-20°C	+	2	4	6.5	8.5
4°C	+	2.5	5.5	8	10.5
<b>20°C</b>	<b>1</b>	<b>3</b>	<b>6</b>	<b>9</b>	<b>12</b>
40°C	1	3	6.5	9.5	-
55°C	1	3.5	7	10	-

+ Utilizzare lubrificatori di dimensioni maggiori e dalla maggiore durata

- Utilizzare un lubrificatore di dimensione minore e dalle minore durata

**simalube 250**

Durata (giorni)	30	90	180	270	360
ml/giorno	8,33	2,78	1,39	0,93	0,69
Temperatura	Regolazi- one	Regolazi- one	Regolazi- one	Regolazi- one	Regolazi- one
-20°C	++	2	4.5	7.5	9.5
4°C	++	2.5	5.5	8	10.5
<b>20°C</b>	<b>1</b>	<b>3</b>	<b>6</b>	<b>9</b>	<b>12</b>
40°C	1	3	6	9	-
55°C	1	3.5	6.5	9.5	-

++ Utilizzare l'adattatore doppio

- Utilizzare un lubrificatore di dimensioni minori e dalla minore durata

I valori si riferiscono a condizioni di laboratorio (SLO1) senza contropressione. In presenza di basse temperature i valori possono variare a seconda del tipo di grasso utilizzato. Una volta terminata la durata impostata, i lubrificatori devono essere sostituiti anche se non sono completamente vuoti.

La quantità di grasso erogata giornalmente è influenzata dai seguenti fattori:

- contropressione/resistenza nei condotti
- temperatura ambiente
- viscosità del grasso

### Periodo di rodaggio

Fino alla prima fuoriuscita di lubrificante, il lubrificatore automatico necessita un periodo di rodaggio, che varia in base alla quantità erogata selezionata, alle dimensioni del lubrificatore e alla temperatura d'esercizio. Con una temperatura ambiente di 20 °C e una regolazione della durata di erogazione pari a 12 mesi, il lubrificatore eroga il lubrificante per una settimana. A basse temperature (-20 °C) o in caso di lubrificatori piccoli (30 ml), il periodo di rodaggio raddoppia.

In questi casi è possibile ridurlo regolando il lubrificatore automatico per uno o due giorni su una durata di erogazione di un mese e successivamente adattandolo alla durata desiderata.

### Programmi online gratuiti:



**Calculation Pro**



**Lubechart**

### simatec app «world of maintenance»:



### Nota:

Per un funzionamento affidabile è indispensabile che i condotti di ingrassaggio siano liberi e lubrificati. Occorre inoltre garantire che tali condotti non siano otturati. Per questo motivo, prima di ogni messa in funzione il punto di ingrassaggio deve essere ingrassato tramite una pompa a grasso.

È possibile regolare e disattivare l'erogazione del simalube durante il suo funzionamento. I valori indicati sul disco di regolazione sono in rapporto alle condizioni di laboratorio (vedi a pag. 28).

A seconda dell'impostazione e della temperatura, la prima fuoriuscita del grasso avverrà dopo qualche ora dall'attivazione (per la regolazione a lunga durata dopo qualche giorno). L'operatore deve verificare a cadenza regolare il funzionamento del simalube. I tubi di raccordo non devono avere una lunghezza superiore a 0,5 m. Diametro interno raccomandato: 6-8 mm. Non sono ammessi resistenze nei condotti, passaggi stretti ed angoli retti. In caso di vibrazioni o di forti accelerazioni, utilizzare il supporto di montaggio (accessori pag. 33-39). In presenza di lunghe linee di lubrificazione o di una contropressione forte utilizza simalube IMPULSE connect (Art. 230.1010). Il simalube può essere utilizzato soltanto per il rifornimento di **un punto** di ingrassaggio. Non sono ammesse ramificazioni. Una volta che il lubrificatore è installato e attivato, non deve essere rimosso e montato su un altro punto di lubrificazione.

## Istruzioni per lo smaltimento

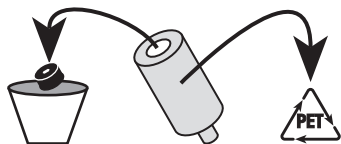

- 1) Svitare la testa di comando (SW21) e depositarla senza smontarla nel contenitore smaltimento batterie. **Nota:** per evitare rischi non rimuovere il generatore di gas vicino a fiamme.
- 2) Gettare il contenitore vuoto nell'apposito recipiente per smaltimento plastica. Se il lubrificatore contiene ancora del grasso, smaltire secondo le normative locali.

## Riempimento e nuova ricarica (per piccole quantità)

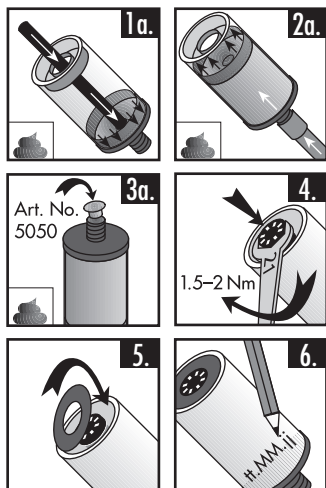

### Primo riempimento con grasso

- 1a. Con un soffio d'aria compressa o servendosi di una barra di plastica (diametro 7 mm), spostare il pistone completamente in avanti in direzione della calotta ovvero dell'apertura di scarico.
- 2a. Avvitare il nipplo di ricarica (Art. 290.3012) e collegare la pompa a grasso oppure avvitare il nipplo di raccordo (Art. 290.3013 ovvero 290.3014) sulla pompa a grasso. In questo modo, il lubrificatore viene premuto contro l'adattatore durante tutta la procedura di riempimento, evitando così di dovere nuovamente avvitare il nipplo di ricarica. Premere il grasso nel lubrificatore evitando che si formino bolle. Proseguire la procedura di riempimento fino a quando il pistone è completamente arretrato. Non sovraccaricare! **Attenzione: Le presse a mano possono esercitare una pressione fino a 80 bar. Questa può essere sufficiente a distruggere il lubrificatore!**

- 3a. Se occorre riporre temporaneamente il lubrificatore, inserire il tappo.
4. Installare la testa di comando (fare attenzione a posizionare correttamente l'o-ring) e avvitarla con una chiave di serraggio dinamometrica da 1,5-2,0 Nm. **Usare sempre teste di comando originali simalube.**
5. Fissare la rondella.
6. Annotare sull'etichetta la denominazione del grasso e la data di riempimento.

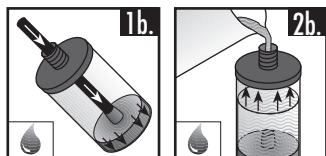

### Primo riempimento con olio

- 1b. Tirare completamente indietro il pistone (in direzione della testa di comando).
- 2b. Versare l'olio dall'apertura della calotta.
- 3b. Inserire il tappo valvola di non ritorno (giallo, Art. 290.5060).
- 4.-6. Come sopra con grasso.



### Nuova ricarica con grasso od olio

1. Togliere la rondella.
2. Svitare la testa di comando (SW 21) e depositarla senza smontarla nel contenitore smaltimento batterie. Non svitare mai in prossimità di fiamme libere. Successivamente procedere come per il primo riempimento con grasso od olio.

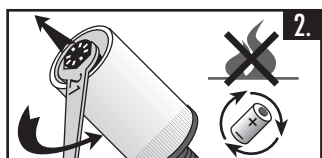

### Nota:

Per poter garantire un funzionamento affidabile del lubrificatore automatico simalube, utilizzare soltanto grassi che siano stati collaudati e approvati per l'utilizzo nel simalube. In particolare, occorre fare attenzione a una buona stabilità del grasso rispetto al filtraggio dell'olio di base e a una bassa classe di consistenza (max. NLGI 2). In caso di lubrificatori riempiti personalmente, così come in caso di utilizzo di lubrificanti non esplicitamente approvati, la garanzia decade. In caso di dubbio, contattare la nostra assistenza tecnica o il proprio rivenditore.

## Prontuario dei lubrificanti

La gamma di lubrificanti per il simalube comprende grassi e oli testati ad alta prestazione, che si adattano alle esigenze più particolari. Le caratteristiche e le avvertenze sono indicate nelle schede tecniche redatte dai produttori di oli e grassi. Per tutti i grassi sono disponibili le schede tecniche (on-line all'indirizzo: [www.simatec.com](http://www.simatec.com)). Consultare tali schede per le disposizioni/indicazioni di sicurezza dei produttori di grassi/oli.

Nr.	Applicazione	Variazioni temperatura (nella zona di ingrassaggio)
<b>SL01</b>	Grasso universale	-30/+120 °C
<b>SL02</b>	Grasso universale + MoS <sub>2</sub>	-25/+130 °C
<b>SL04</b>	Grasso per alte temperatura	-20/+160 °C
<b>SL06</b>	Grasso fluido (EP)	-30/+120 °C
<b>SL09</b>	Grasso biodegradabile	-20/+80/100 °C
<b>SL10</b>	Grasso atossico (NSF H1)	-40/+130 °C
<b>SL12</b>	Grasso semi-fluido per alimenti (NSF H1)	-40/+130 °C
<b>SL14</b>	Olio per catene (EP)	-10/+90 °C
<b>SL15</b>	Olio per alte temperatura (EP)	-30/+250 °C
<b>SL16</b>	Olio di macchina	-20/+100 °C
<b>SL18</b>	Olio atossico (NSF H1)	-15/+150 °C
<b>SL19</b>	Olio biodegradabile catena	-15/+100 °C
<b>SL24</b>	Grasso per una vasta gamma di temperature (EP)	-30/+140 °C
<b>SL25</b>	Grasso per alte temperature	-20/+160 °C
<b>SL26</b>	Grasso alta resa (EP)	-20/+150 °C

Il simalube può essere fornito vuoto o con altri lubrificanti. Chiedete informazioni. Il simalube può essere ugualmente utilizzato con oli di differente viscosità.

### Dichiarazione di conformità UE

#### simatec ag

Stadthof 2 in CH-3380 Wangen a. Aare  
 Qui di seguito dichiara che il

lubrificatore automatico continuo

#### simalube & simalube multipoint

è stato progettato e fabbricato secondo  
 le direttive

**Direttiva 2014/34/UE del Parlamento  
 Europeo e del Consiglio concernente  
 l'armonizzazione delle legislazioni degli  
 Stati membri relative agli apparecchi e  
 sistemi di protezione destinati a essere  
 utilizzati in atmosfera potenzialmente  
 esplosiva.**

Sono state applicate le seguenti norme:

**EN 60079-0:2018**

**EN 60079-11:2012**

**EN 50303:2000**

Ente al quale è stata notificata la  
 comunicazione:

**DEKRA Certification B.V.**

**NL-6825 MJ Arnhem**

Numero di registrazione: 0344

Certificazione No.

**KEMA 09ATEX0098X**

Wangen a. Aare, 01.01.2022



Mischa Wyssmann, Managing Director / CEO

Prodotto da:

**simatec ag**

Stadthof 2, CH-3380 Wangen a. Aare  
[www.simalube.com](http://www.simalube.com)

**simalube**<sup>®</sup>  
 smart lubrication



## Zubehör / Accessories / Accessoires Accesorios / Accessori

**Achtung:** Nur Originalzubehör verwenden. Bei technisch anspruchsvollen oder aussergewöhnlichen Anwendung kontaktieren Sie bitte unsere technische Abteilung oder Ihren Händler.

**Note:** Use only original accessories. If you have technically demanding or unusual applications, please contact our technical department or your local distributor.

**Attention:** n'utiliser que les accessoires originaux. Pour des installations techniquement complexes ou inhabituelles, veuillez consulter notre service technique ou votre distributeur.

**Atención:** Use solamente accesorios originales. Para aplicaciones técnicamente complejas o no estándares, póngase en contacto con nuestro departamento técnico o con su distribuidor.

**Attenzione:** usare solo gli accessori originali. In caso di applicazioni tecnicamente impegnative e straordinarie, contattare il nostro reparto tecnico o il proprio rivenditore.

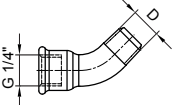
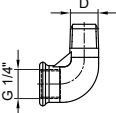
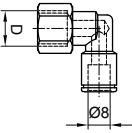
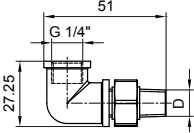
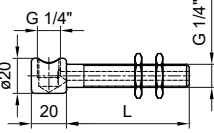
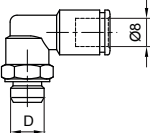
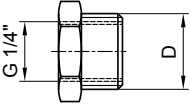
	<p><b>Bogen 45° / Bent connection 45° / Coude 45° / Codo 45° / Gomito 45°</b></p> <table border="1"> <tr> <td>D</td> <td>R 1/4</td> </tr> <tr> <td>Nr.</td> <td>290.1001</td> </tr> </table>	D	R 1/4	Nr.	290.1001		
D	R 1/4						
Nr.	290.1001						
	<p><b>Bogen 90° / Bent connection 90° / Coude 90° / Codo 90° / Gomito 90°</b></p> <table border="1"> <tr> <td>D</td> <td>R 1/4</td> </tr> <tr> <td>Nr.</td> <td>290.1002</td> </tr> </table>	D	R 1/4	Nr.	290.1002		
D	R 1/4						
Nr.	290.1002						
	<p><b>Winkelverschraubung drehbar / Elbow rotary / Raccord fileté coude rotatif / Conector rápido ángulo y rotativo / Gomito rotante</b></p> <table border="1"> <tr> <td>D</td> <td>G 1/4</td> </tr> <tr> <td>Nr.</td> <td>290.1003</td> </tr> </table>	D	G 1/4	Nr.	290.1003		
D	G 1/4						
Nr.	290.1003						
	<p><b>Bogen 90° schwenkbar / Bent connection 90° swiveling / Coude 90° pivotant / Codo 90° orientable / Gomito 90° orientabile</b></p> <table border="1"> <tr> <td>D</td> <td>R 1/4</td> </tr> <tr> <td>Nr.</td> <td>290.1004</td> </tr> </table>	D	R 1/4	Nr.	290.1004		
D	R 1/4						
Nr.	290.1004						
	<p><b>90° Anschluss mit Gewinde inkl. 2 Muttern (nur für Öl) / 90° connection with thread incl. 2 nuts (only for oil) / Pièce de raccordement avec filetage 90° incl. 2 écrous (pour huile) / Conector 90° con rosca incl. 2 tuercas (solo para aceite) / Raccordo 90° filettato incl. 2 dadi (solo per l'olio)</b></p> <table border="1"> <tr> <td>L</td> <td>70</td> <td>[ mm ]</td> </tr> <tr> <td>Nr.</td> <td colspan="2">290.1005</td> </tr> </table>	L	70	[ mm ]	Nr.	290.1005	
L	70	[ mm ]					
Nr.	290.1005						
	<p><b>Winkelverschraubung drehbar / Elbow rotary / Raccord fileté coude rotatif / Conector rápido ángulo y rotativo / Gomito rotante</b></p> <table border="1"> <tr> <td>D</td> <td>G 1/8</td> <td>G 1/4</td> </tr> <tr> <td>Nr.</td> <td>290.1007</td> <td>290.1008</td> </tr> </table>	D	G 1/8	G 1/4	Nr.	290.1007	290.1008
D	G 1/8	G 1/4					
Nr.	290.1007	290.1008					
	<p><b>Anschlussnippel / Connecting nipple / Raccord / Niple de conexión / Nippolo di raccordo</b></p> <table border="1"> <tr> <td>D</td> <td>G 3/8</td> <td>G 1/2</td> </tr> <tr> <td>Nr.</td> <td>290.1010</td> <td>290.1011</td> </tr> </table>	D	G 3/8	G 1/2	Nr.	290.1010	290.1011
D	G 3/8	G 1/2					
Nr.	290.1010	290.1011					

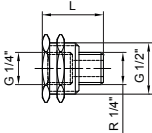
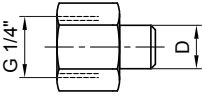
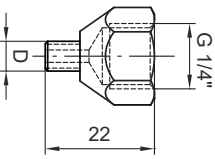
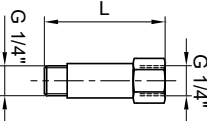
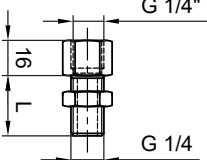
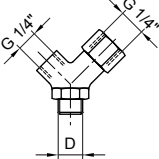
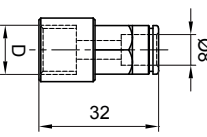
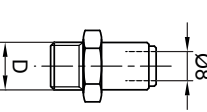

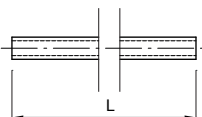
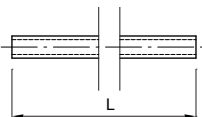
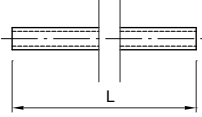
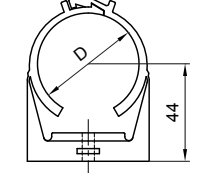
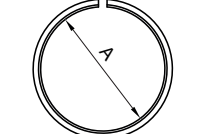
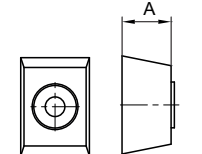
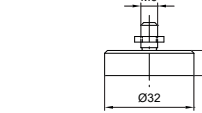
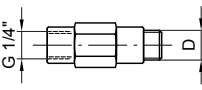
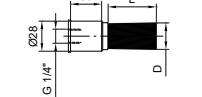

	<p><b>Befestigungsrippel</b> G<math>\frac{1}{2}</math>"-R<math>\frac{1}{4}</math>" / <b>Fixation nipple</b> G<math>\frac{1}{2}</math>"-R<math>\frac{1}{4}</math>" / <b>Raccord de fixation</b> G<math>\frac{1}{2}</math>"-R<math>\frac{1}{4}</math>" / <b>Niple de montaje</b> G<math>\frac{1}{2}</math>"-R<math>\frac{1}{4}</math>" / <b>Nippolo di montaggio</b> G<math>\frac{1}{2}</math>"-R<math>\frac{1}{4}</math>"</p> <table border="1"> <tr> <td><b>L</b></td> <td>25</td> <td>[ mm ]</td> </tr> <tr> <td><b>Nr.</b></td> <td colspan="2">290.1015</td> </tr> </table>	<b>L</b>	25	[ mm ]	<b>Nr.</b>	290.1015																			
<b>L</b>	25	[ mm ]																							
<b>Nr.</b>	290.1015																								
	<p><b>Reduziernippel / Reducing nipple / Raccord de reduction / Niple de reducción / Nippolo di riduzione</b></p> <table border="1"> <tr> <td><b>D</b></td> <td>G 1/8</td> <td>G 1/4</td> <td>M6</td> <td>M8</td> <td>M8x1</td> </tr> <tr> <td><b>Nr.</b></td> <td>290.1020</td> <td>290.1021</td> <td>290.1022</td> <td>290.1023</td> <td>290.1024</td> </tr> <tr> <td><b>D</b></td> <td>M10</td> <td>M10x1</td> <td>M12</td> <td>M12x1.5</td> <td>UNF 1/4</td> </tr> <tr> <td><b>Nr.</b></td> <td>290.1025</td> <td>290.1026</td> <td>290.1027</td> <td>290.1028</td> <td>290.1121</td> </tr> </table>	<b>D</b>	G 1/8	G 1/4	M6	M8	M8x1	<b>Nr.</b>	290.1020	290.1021	290.1022	290.1023	290.1024	<b>D</b>	M10	M10x1	M12	M12x1.5	UNF 1/4	<b>Nr.</b>	290.1025	290.1026	290.1027	290.1028	290.1121
<b>D</b>	G 1/8	G 1/4	M6	M8	M8x1																				
<b>Nr.</b>	290.1020	290.1021	290.1022	290.1023	290.1024																				
<b>D</b>	M10	M10x1	M12	M12x1.5	UNF 1/4																				
<b>Nr.</b>	290.1025	290.1026	290.1027	290.1028	290.1121																				
	<p><b>Reduziernippel starke Ausführung</b> In<sub>ox</sub> / <b>Reducing nipple heavy-duty type</b> In<sub>ox</sub> / <b>Raccord de reduction execution renforcée</b> In<sub>ox</sub> / <b>Niple de reducción alta resistencia</b> In<sub>ox</sub> / <b>Nippolo di riduzione esecuzione forte</b> In<sub>ox</sub></p> <table border="1"> <tr> <td><b>D</b></td> <td>M6</td> <td>UNF 1/4</td> <td>[ mm ]</td> </tr> <tr> <td><b>Nr.</b></td> <td colspan="2">290.1500</td> <td>290.1501</td> </tr> </table>	<b>D</b>	M6	UNF 1/4	[ mm ]	<b>Nr.</b>	290.1500		290.1501																
<b>D</b>	M6	UNF 1/4	[ mm ]																						
<b>Nr.</b>	290.1500		290.1501																						
	<p><b>Verlängerung / Extension / Rallonge / Prolongador / Prolunga</b></p> <table border="1"> <tr> <td><b>L</b></td> <td>10</td> <td>35</td> <td>50</td> <td>[ mm ]</td> </tr> <tr> <td><b>Nr.</b></td> <td>290.1021</td> <td>290.1040</td> <td colspan="2">290.1041</td> </tr> </table>	<b>L</b>	10	35	50	[ mm ]	<b>Nr.</b>	290.1021	290.1040	290.1041															
<b>L</b>	10	35	50	[ mm ]																					
<b>Nr.</b>	290.1021	290.1040	290.1041																						
	<p><b>Schottverschraubung</b> 25 mm, 1 Mutter/60 mm, 2 Muttern / <b>Screwed connection with hole</b> 25 mm, 1 nut/60 mm, 2 nuts / <b>Raccord de traversée</b> 25 mm, 1 écrou/60 mm, 2 écrous / <b>Tornillo de conexión</b> 25 mm, 1 tuerca/60 mm, 2 tuercas / <b>Raccordo filettato c. foro</b> 25 mm, 1 dado/60 mm, 2 dadi</p> <table border="1"> <tr> <td><b>L</b></td> <td>25</td> <td>60</td> <td>[ mm ]</td> </tr> <tr> <td><b>Nr.</b></td> <td>290.1045</td> <td colspan="2">290.1046</td> </tr> </table>	<b>L</b>	25	60	[ mm ]	<b>Nr.</b>	290.1045	290.1046																	
<b>L</b>	25	60	[ mm ]																						
<b>Nr.</b>	290.1045	290.1046																							
	<p><b>Y-Anschlussstück</b> enthält Reduziernippel 290.1021 / <b>Y-manifold</b> contains reduction 290.1021 / <b>Raccord Y</b> contient raccord de réduction 290.1021 / <b>Conexión en Y</b> contiene reducción 290.1021 / <b>Raccordo a Y</b> contiene nippolo di riduzione 290.1021</p> <table border="1"> <tr> <td><b>D</b></td> <td>R 1/4</td> </tr> <tr> <td><b>Nr.</b></td> <td>290.1050</td> </tr> </table>	<b>D</b>	R 1/4	<b>Nr.</b>	290.1050																				
<b>D</b>	R 1/4																								
<b>Nr.</b>	290.1050																								
	<p><b>Steckverschraubung</b> für Schlauch ø 8 mm / <b>Quick connection</b> for hose ø 8 mm / <b>Raccord fileté</b> pour tuyau ø 8 mm / <b>Conector rápido</b> para manguera de ø 8 mm / <b>Raccordo ad innesto</b> per tubo ø 8 mm</p> <table border="1"> <tr> <td><b>D</b></td> <td>G 1/4</td> </tr> <tr> <td><b>Nr.</b></td> <td>290.1060</td> </tr> </table>	<b>D</b>	G 1/4	<b>Nr.</b>	290.1060																				
<b>D</b>	G 1/4																								
<b>Nr.</b>	290.1060																								
	<p><b>Steckverschraubung</b> für Schlauch ø 8 mm / <b>Quick connection</b> for hose ø 8 mm / <b>Raccord fileté</b> pour tuyau ø 8 mm / <b>Conector rápido</b> para manguera de ø 8 mm / <b>Raccordo ad innesto</b> per tubo ø 8 mm</p> <table border="1"> <tr> <td><b>D</b></td> <td>G 1/8</td> <td>G 1/4</td> <td>G 3/8</td> </tr> <tr> <td><b>Nr.</b></td> <td>290.1070</td> <td>290.1071</td> <td>290.1072</td> </tr> </table>	<b>D</b>	G 1/8	G 1/4	G 3/8	<b>Nr.</b>	290.1070	290.1071	290.1072																
<b>D</b>	G 1/8	G 1/4	G 3/8																						
<b>Nr.</b>	290.1070	290.1071	290.1072																						

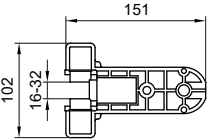
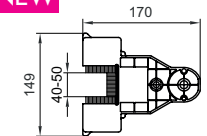
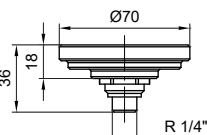
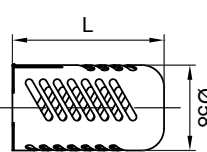
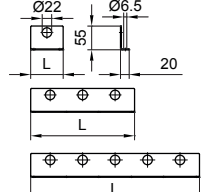
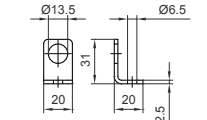
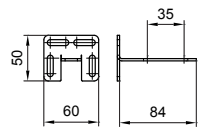
	<p><b>Schlauch</b> erhältlich pro Meter / <b>Hose</b> available by the metre / <b>Tuyau</b> disponible au mètre / <b>Tubo</b> disponibile por metro / <b>Tubo</b> disponibile al metro</p> <table border="1"> <tr> <td>L</td> <td>per metre</td> <td>ø 8/6 mm</td> </tr> <tr> <td>Nr.</td> <td colspan="2">290.2000/...m</td> </tr> </table>	L	per metre	ø 8/6 mm	Nr.	290.2000/...m					
L	per metre	ø 8/6 mm									
Nr.	290.2000/...m										
	<p><b>Schlauch für Temperaturen bis 260 °C</b> / <b>Hose for temperatures up to 260 °C</b> / <b>Tuyau pour des températures jusqu'à 260 °C</b> / <b>Manguera para temperaturas hasta 260 °C</b> / <b>Tubo flessibile per temperature fino a 260 °C</b></p> <table border="1"> <tr> <td>L</td> <td>per metre</td> <td>ø 8/6 mm</td> </tr> <tr> <td>Nr.</td> <td colspan="2">290.2002/...m</td> </tr> </table>	L	per metre	ø 8/6 mm	Nr.	290.2002/...m					
L	per metre	ø 8/6 mm									
Nr.	290.2002/...m										
	<p><b>Schlauch für kleine Radien</b> / <b>Hose for small bend radius</b> / <b>Tuyau pour petit rayon de courbe</b> / <b>Manguera a para las esquinas pronunciadas</b> / <b>Tubo flessibile per curve a raggio stretto</b></p> <table border="1"> <tr> <td>L</td> <td>per metre</td> <td>ø 8/6 mm</td> </tr> <tr> <td>Nr.</td> <td colspan="2">290.2004/...m</td> </tr> </table>	L	per metre	ø 8/6 mm	Nr.	290.2004/...m					
L	per metre	ø 8/6 mm									
Nr.	290.2004/...m										
	<p><b>Halteschelle für simalube/Pinsel</b> Kunststoff / <b>Clamp for simalube/round brush</b> Plastic / <b>Bride de fixation pour simalube/pinceau</b> Plastique / <b>Abrazadera para simalube/escobilla cilíndrica</b> Plástico / <b>Fascetta di fissaggio per simalube/spazzola cilindrica</b> Plastica</p> <table border="1"> <tr> <td>D</td> <td>50</td> <td>28</td> <td>22</td> <td>[ mm ]</td> </tr> <tr> <td>Nr.</td> <td>290.2010</td> <td>290.2013</td> <td>290.2015</td> <td></td> </tr> </table>	D	50	28	22	[ mm ]	Nr.	290.2010	290.2013	290.2015	
D	50	28	22	[ mm ]							
Nr.	290.2010	290.2013	290.2015								
	<p><b>Adapter für Schelle (60 mm)</b> Kunststoff / <b>Adapter for clamp (60 mm)</b> Plastic / <b>Adaptateur de fixation (60 mm)</b> Plastique / <b>Adaptador para abrazadera (60 mm)</b> Plástico / <b>Adattatore per fascetta (60 mm)</b> Plastica</p> <table border="1"> <tr> <td>A</td> <td>50</td> <td>[ mm ]</td> </tr> <tr> <td>Nr.</td> <td colspan="2">290.2012</td> </tr> </table>	A	50	[ mm ]	Nr.	290.2012					
A	50	[ mm ]									
Nr.	290.2012										
	<p><b>Distanzhalter zu Halteschelle für Pinsel</b> 290.2013 / <b>Distance holder to clamp for round brush</b> 290.2013 / <b>Entretoise pour bride de fixation pour pinceau</b> 290.2013 / <b>Espaciador para abrazadera p. escobilla cilíndrica</b> 290.2013 / <b>Distanziatore per fascetta per spazzola cilindrica</b> 290.2013</p> <table border="1"> <tr> <td>A</td> <td>15</td> <td>[ mm ]</td> </tr> <tr> <td>Nr.</td> <td colspan="2">290.2014</td> </tr> </table>	A	15	[ mm ]	Nr.	290.2014					
A	15	[ mm ]									
Nr.	290.2014										
	<p><b>Magnetfuss zu Halteschelle</b> / <b>Magnetic fixture for clamps</b> / <b>Fixation magnétique pour brides</b> / <b>Fijación magnética para abrazadera</b> / <b>Attacco magnetico per fascette</b></p> <table border="1"> <tr> <td>Nr.</td> <td colspan="2">290.2019</td> </tr> </table>	Nr.	290.2019								
Nr.	290.2019										
	<p><b>Rückschlagventil</b> / <b>Non-return valve</b> / <b>Clapet antiretour</b> / <b>Válvula de retención</b> / <b>Valvola di non ritorno</b></p> <table border="1"> <tr> <td>D</td> <td>G 1/8</td> <td>G 1/4</td> </tr> <tr> <td>Nr.</td> <td>290.2020</td> <td>290.2021</td> </tr> </table>	D	G 1/8	G 1/4	Nr.	290.2020	290.2021				
D	G 1/8	G 1/4									
Nr.	290.2020	290.2021									
	<p><b>Pinsel</b> / <b>Round brush</b> / <b>Pinceau</b> / <b>Pincel</b> / <b>Spazzola cilindrica</b></p> <table border="1"> <tr> <td>DxL</td> <td>ø 25x45</td> <td>[ mm ]</td> </tr> <tr> <td>Nr.</td> <td colspan="2">290.2034</td> </tr> </table>	DxL	ø 25x45	[ mm ]	Nr.	290.2034					
DxL	ø 25x45	[ mm ]									
Nr.	290.2034										

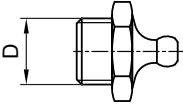
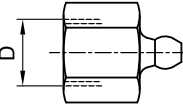
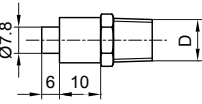
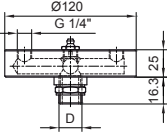
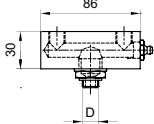
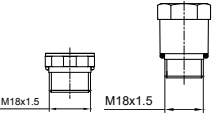
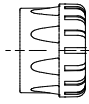
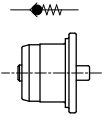
	<p><b>Pinsel kurz / Round brush short / Pinceau court / Pincel / Spazzola cilindrica</b></p> <p><b>DxL</b>   <math>\varnothing 25 \times 15</math> [ mm ]</p> <p><b>Nr.</b>   290.2041</p>						
	<p><b>Bürste / Brush / Broses / Cepillo / Spazzola rettangolare</b></p> <table border="1"> <tr> <td><b>L</b></td> <td>40</td> <td>70</td> <td>100</td> <td>25</td> <td>[ mm ]</td> </tr> </table> <p><b>Nr.</b>   290.2035   290.2036   290.2037   290.2038</p>	<b>L</b>	40	70	100	25	[ mm ]
<b>L</b>	40	70	100	25	[ mm ]		
	<p><b>Bürste für die Lebensmittelindustrie / Brush for food applications / Broses pour des applications alimentaire / Cepillo alimenticio / Spazzola rettangolare alimentare</b></p> <table border="1"> <tr> <td><b>L</b></td> <td>40</td> <td>70</td> <td>100</td> <td>25</td> <td>[ mm ]</td> </tr> </table> <p><b>Nr.</b>   290.2035-FN   290.2036-FN   290.2037-FN   290.2038-FN</p>	<b>L</b>	40	70	100	25	[ mm ]
<b>L</b>	40	70	100	25	[ mm ]		
	<p><b>Bürste, Anschluss seitlich / Brush, lateral connection / Broses, à connexion latérale / Cepillo, conexión lateral / Spazzola rettangolare, attacco laterale</b></p> <table border="1"> <tr> <td><b>L</b></td> <td>40</td> <td>70</td> <td>100</td> <td>25</td> <td>[ mm ]</td> </tr> </table> <p><b>Nr.</b>   290.2035-S   290.2036-S   290.2037-S   290.2038-S</p>	<b>L</b>	40	70	100	25	[ mm ]
<b>L</b>	40	70	100	25	[ mm ]		
	<p><b>Bürste Anschluss seitlich für die Lebensmittelindustrie / Brush lateral connection for food applications / Broses à connexion latérale pour applications alimentaire / Cepillo conexión lateral alimentación / Spazzola rettangolare, attacco laterale alimentare</b></p> <table border="1"> <tr> <td><b>L</b></td> <td>40</td> <td>70</td> <td>100</td> <td></td> <td>[ mm ]</td> </tr> </table> <p><b>Nr.</b>   290.2035-SFN   290.2036-SFN   290.2037-SFN</p>	<b>L</b>	40	70	100		[ mm ]
<b>L</b>	40	70	100		[ mm ]		
	<p><b>Bürste für hohe Temperaturen / Brush for high temperatures / Brosse pour haute température / Cepillo para altas temperaturas / Spazzole per alte temperature</b></p> <table border="1"> <tr> <td><b>L</b></td> <td>25</td> <td></td> <td></td> <td></td> <td>[ mm ]</td> </tr> </table> <p><b>Nr.</b>   290.2050</p>	<b>L</b>	25				[ mm ]
<b>L</b>	25				[ mm ]		
	<p><b>Bürste für hohe Temperaturen Anschluss oben und seitlich / Brush for high temperatures connection on the top or the side / Brosse pour haute température connection latérale ou par le haut / Cepillo para altas temperaturas conexión superior o lateral / Spazzole per alte temperature attacco frontale o laterale</b></p> <table border="1"> <tr> <td><b>L</b></td> <td>40</td> <td>100</td> <td></td> <td></td> <td>[ mm ]</td> </tr> </table> <p><b>Nr.</b>   290.2051   290.2053</p>	<b>L</b>	40	100			[ mm ]
<b>L</b>	40	100			[ mm ]		
	<p><b>Aufzugsbürste 5-16 mm, Höhe 32 mm / Elevator brush 5-16 mm, height 32 mm / Brosse pour ascenseurs 5-16 mm, hauteur 32 mm / Escobilla para ascensores 5-16 mm, altura 32 mm / Spazzola per guida ascensori 5-16 mm, alta 32 mm</b></p> <p><b>Nr.</b>   290.2039</p>						
	<p><b>Aufzugsbürste klein 5-16 mm, Höhe 32 mm / Elevator brush small 5-16 mm, height 32 mm / Petite brosse pour ascenseurs 5-16 mm, hauteur 32 mm / Escobilla pequeña para ascensores 5-16 mm, altura 32 mm / Spazzola piccola per guida ascensori 5-16 mm, alta 32 mm</b></p> <p><b>Nr.</b>   290.2042</p>						

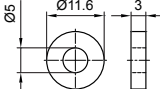
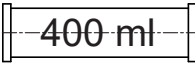
	<p><b>Aufzugsbürste</b> 16–32 mm, Höhe 32 mm / <b>Elevator brush</b> 16–32 mm, height 32 mm / <b>Brosse pour ascenseurs</b> 16–32 mm, hauteur 32 mm / <b>Escobilla para ascensores</b> 16–32 mm, altura 32 mm / <b>Spazzola per guida ascensori</b> 16–32 mm, alta 32 mm</p> <p>Nr.   290.2044</p>										
<p><b>NEW</b></p> 	<p><b>Bürste für Führungsschienen</b> 40–50 mm, Höhe 32 mm / <b>Guide rail brush</b> 40–50 mm, height 32 mm / <b>Brosse pour rails de guidage</b> 40–50 mm, hauteur 32 mm / <b>Cepillo de carril guía</b> 40–50 mm, altura 32 mm / <b>Spazzole per guide</b> 40–50 mm, alta 32 mm</p> <p>Nr.   290.2046</p>										
	<p><b>Montagesupport</b> für alle simalube Grössen / <b>Mounting support</b> for all simalube sizes / <b>Support de montage</b> pour toutes les tailles de simalube / <b>Soporte de montaje</b> para todos los tamaños de simalube / <b>Supporto di montaggio</b> per simalube di ogni dimensione</p> <p>Nr.   290.2080</p>										
	<p><b>Schutzhaube</b> zu Montagesupport 290.2080 / <b>Protective cover</b> to mounting support 290.2080 / <b>Capot de protection</b> pour support de montage 290.2080 / <b>Cubierta protectora</b> para soporte de montaje 290.2080 / <b>Calotta protezione</b> per supporto montaggio 290.2080</p> <table border="1" data-bbox="367 919 968 991"> <tr> <td></td> <td>≤125 ml</td> <td>250 ml</td> <td></td> </tr> <tr> <td><b>L</b></td> <td>105</td> <td>195</td> <td>[ mm ]</td> </tr> </table> <p>Nr.   290.2081   290.2085</p>		≤125 ml	250 ml		<b>L</b>	105	195	[ mm ]		
	≤125 ml	250 ml									
<b>L</b>	105	195	[ mm ]								
	<p><b>Befestigungswinkel</b> zu Montagesupport simalube / <b>Bracket</b> to mounting support simalube / <b>Equerre de fixation</b> pour support de montage simalube / <b>Soporte de montaje</b> se utiliza con el soporte simalube / <b>Staffa di sostegno</b> per supporto di montaggio simalube</p> <table border="1" data-bbox="367 1195 968 1257"> <tr> <td></td> <td>1x</td> <td>3x</td> <td>5x</td> <td></td> </tr> <tr> <td><b>L</b></td> <td>75</td> <td>240</td> <td>390</td> <td>[ mm ]</td> </tr> </table> <p>Nr.   290.2082   290.2083   290.2084</p>		1x	3x	5x		<b>L</b>	75	240	390	[ mm ]
	1x	3x	5x								
<b>L</b>	75	240	390	[ mm ]							
	<p><b>Montagewinkel</b> für simalube 15–60 ml / <b>Bracket</b> for simalube 15–60 ml / <b>Equerre de montage</b> pour simalube 15–60 ml / <b>Soporte de montaje</b> para simalube 15–60 ml / <b>Staffa di sostegno</b> per simalube 15–60 ml</p> <p>Nr.   290.2087</p>										
	<p><b>Support</b> universell verstellbar / <b>Bracket</b> universally adjustable / <b>Support réglage universel</b> / <b>Soporte</b> universal regulable / <b>Staffa</b> con regolazione universale</p> <p>Nr.   290.2800</p>										

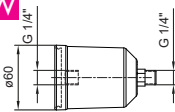
	<p><b>Schmiernippel</b> zum Durchschmieren und Füllen der Fettkanäle / <b>Connector nipple</b> for cleaning and filling of grease lines / <b>Graisseur</b> pour nettoyer et remplir les canaux de graissage / <b>Niple de conexión</b> para limpiar y llenar las tuberías de lubricación / <b>Niplo di connessione</b> per ingrassare e riempire i condotti di ingrassaggio</p> <p>D   R 1/4</p> <p>Nr.   290.3011</p>										
	<p><b>Nachfüllnippel</b> zum Nachfüllen des simalube / <b>Refill nipple</b> for refilling of simalube / <b>Graisseur de recharge</b> pour la recharge du simalube / <b>Niple de recarga</b> para la recarga del simalube / <b>Niplo di ricarica</b> per la ricarica del simalube</p> <p>D   G 1/4</p> <p>Nr.   290.3012</p>										
	<p><b>Nachfüllnippel</b> zum Befüllen des simalube mit Fettpressenfüller / <b>Refill nipple</b> to grease gun filler for filling simalube / <b>Graisseur de recharge</b> pour appareil de remplissage de pompes à graisse / <b>Niple de recarga</b> para llenado de simalubes / <b>Niplo di ricarica</b> per riempire il simalube con un caricatore per pompa a grasso</p> <p>D   R 1/4   R 3/8</p> <p>Nr.   290.3013   290.3014</p>										
	<p><b>4-fach-Adapter</b> / <b>4-fold adapter</b> / <b>Adaptateur quadruple</b> / <b>Adaptador cuádruple</b> / <b>Adattatore quadruplo</b></p> <p>D   G 1/2   G 1/4</p> <p>Nr.   290.4100   290.4101</p>										
	<p><b>2-fach-Adapter</b> / <b>2-fold adapter</b> / <b>Adaptateur double</b> / <b>Adaptador doble</b> / <b>Adattatore doppio</b></p> <p>D   G 1/2   G 1/4</p> <p>Nr.   290.4102   290.4103</p>										
	<p><b>Antriebskopf</b> zur Wiederbefüllung / <b>Gas generator</b> for refilling / <b>Tête de commande</b> pour la recharge / <b>Celda generadora de gas</b> para recarga / <b>Testa di comando</b> per ricarica</p> <table border="1" data-bbox="353 1365 979 1426"> <tr> <td></td> <td>30 ml</td> <td>60 ml</td> <td>125 ml</td> <td>250 ml</td> </tr> <tr> <td>Nr.</td> <td>220.5004</td> <td>220.5006</td> <td>220.5008</td> <td>220.5010</td> </tr> </table>		30 ml	60 ml	125 ml	250 ml	Nr.	220.5004	220.5006	220.5008	220.5010
	30 ml	60 ml	125 ml	250 ml							
Nr.	220.5004	220.5006	220.5008	220.5010							
	<p><b>Verschlussstopfen Kunststoff</b> / <b>Closing nipple Plastic</b> / <b>Bouchon de fermeture Plastique</b> / <b>Tapón de cierre Plástico</b> / <b>Tappino di chiusura Plastica</b></p> <p>Nr.   290.5050</p>										
	<p><b>Rückschlagventilstopfen gelb Kunststoff</b> / <b>Non-return valve plug yellow Plastic</b> / <b>Bouchon antiretour jaune Plastique</b> / <b>Tapón de válvula de antiretorno amarilla Plástico</b> / <b>Tappo valvola di non ritorno gialla Plastica</b></p> <p>Nr.   290.5060</p>										

	<p><b>Dichtungsring / Gasket ring / Joint d'étanchéité / Arandela (golilla) / Rondella</b></p> <p>Nr.   290.5080</p>																								
	<p><b>Fettkartusche / Grease Cartridge / Cartouche de graisse / Cartucho de grasa / Cartuccia di grasso</b></p> <table border="1"> <tr> <td></td> <td>SL01</td> <td>SL02</td> <td>SL04</td> <td>SL06</td> <td>SL09</td> </tr> <tr> <td>Nr.</td> <td>290.7001</td> <td>290.7002</td> <td>290.7004</td> <td>290.7006</td> <td>290.7009</td> </tr> <tr> <td></td> <td>SL10</td> <td>SL12</td> <td>SL24</td> <td>SL25</td> <td>SL26</td> </tr> <tr> <td>Nr.</td> <td>290.7010</td> <td>290.7012</td> <td>290.7024</td> <td>290.7025</td> <td>290.7026</td> </tr> </table>		SL01	SL02	SL04	SL06	SL09	Nr.	290.7001	290.7002	290.7004	290.7006	290.7009		SL10	SL12	SL24	SL25	SL26	Nr.	290.7010	290.7012	290.7024	290.7025	290.7026
	SL01	SL02	SL04	SL06	SL09																				
Nr.	290.7001	290.7002	290.7004	290.7006	290.7009																				
	SL10	SL12	SL24	SL25	SL26																				
Nr.	290.7010	290.7012	290.7024	290.7025	290.7026																				
	<p><b>Ölflasche 0,5l / Oil bottle 0.5l / Bouteille d'huile 0,5l / Botella de aceite 0,5l / Bottiglia di olio 0,5l</b></p> <table border="1"> <tr> <td></td> <td>SL14</td> <td>SL15</td> <td>SL16</td> <td>SL18</td> <td>SL19</td> </tr> <tr> <td>Nr.</td> <td>290.7114</td> <td>290.7115</td> <td>290.7116</td> <td>290.7118</td> <td>290.7119</td> </tr> </table>		SL14	SL15	SL16	SL18	SL19	Nr.	290.7114	290.7115	290.7116	290.7118	290.7119												
	SL14	SL15	SL16	SL18	SL19																				
Nr.	290.7114	290.7115	290.7116	290.7118	290.7119																				
<p><b>NEW</b></p> 	<p><b>simalube IMPULSE connect, Druckverstärker / Pressure booster / Amplificateur de pression / Amplificador de presión / Potenziatore di pressione</b></p> <p>Nr.   230.1010</p>																								
	<p><b>Batteriepack / Battery pack / Bloc de batteries / Bloque de pilas / Set di batterie</b></p> <p>Power   6V 2,3AH</p> <p>Nr.   230.5000</p>																								



## READY TO LIFT OFF TO THE WORLD OF MAINTENANCE

✖

Explore the next level of automatic lubrication:  
**simalube IMPULSE connect**



Ask your partner or visit our website [www.simatec.com](http://www.simatec.com) for more information.

## Anwenderhinweis für Ölspender

DE

**Vorbereitungen:** Mit einem Messer den vorstehenden Nippel am gelben Rückschlagventilstopfen bündig abschneiden, damit die Öffnung sichtbar wird. Stopfen nicht entfernen!

**Installation des Ölspenders:** Spender mit Rückschlagventilstopfen können in jeder beliebigen Lage installiert werden.

**Wichtig:** Der Rückschlagventilstopfen darf nur für eine Entleerung verwendet werden. Soll der Spender wiederbefüllt werden, muss der Rückschlagventilstopfen ersetzt werden.

## Manual for oil lubricator

EN

**Preparation:** Cut off flush the protruding yellow nipple with a knife; the opening becomes visible. Do not remove plug!

**Installation of the oil lubricator:** Lubricators with non-return valve plug can be installed in any position required.

**Important:** The non-return valve plug can only be used once. If the lubricator is refilled the non-return valve plug must be replaced by a new one.

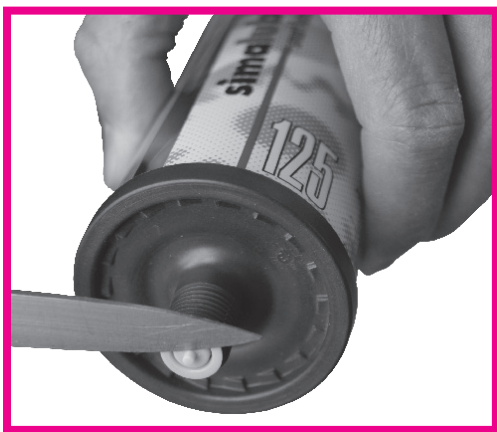

## Consignes d'utilisation des distributeurs d'huile

FR

**Préparations:** Ne pas enlever le bouchon jaune! Il comporte un clapet anti-retour. Couper à fleur, uniquement le têtou avec un couteau.

**Installation du graisseur:** Les graisseurs avec bouchon anti-retour peuvent être installés dans toutes les positions.

**Important:** Le bouchon anti-retour ne doit être utilisé que pour un seul et unique vidage. En cas de recharge du graisseur, le bouchon anti-retour doit être remplacé.

## Manual para el lubricador de aceite

ES

**Preparación:** Corte la protuberancia amarilla del teton con un cuchillo; visualizándose el orificio salida, no saque el tapón.

**Instalación del lubricador de aceite:** Lubricadores con tapón válvula no-retorno pueden ser instalados en cualquier posición que se requiera.

**Importante:** La válvula no-retorno puede ser usada una sola vez. Si el lubricador se rellena, la válvula antirretorno debe ser cambiada por una nueva.

## Manuale per lubrificatori a olio

IT

**Preparazione:** Tagliare solamente la protuberanza gialla con un coltello; l'apertura diventerà visibile. Non togliere il tappo!

**Installazione dei lubrificatori a olio:** I lubrificatori a olio con tappo valvola di non ritorno possono essere installati in qualsiasi posizione richiesta.

**Importante:** Il tappo valvola di non ritorno deve essere usato una volta sola. In caso di ricarica dello stesso lubrificatore bisogna sostituirlo con uno nuovo.